

Developing Oral Language

with

BARRIER GAMES

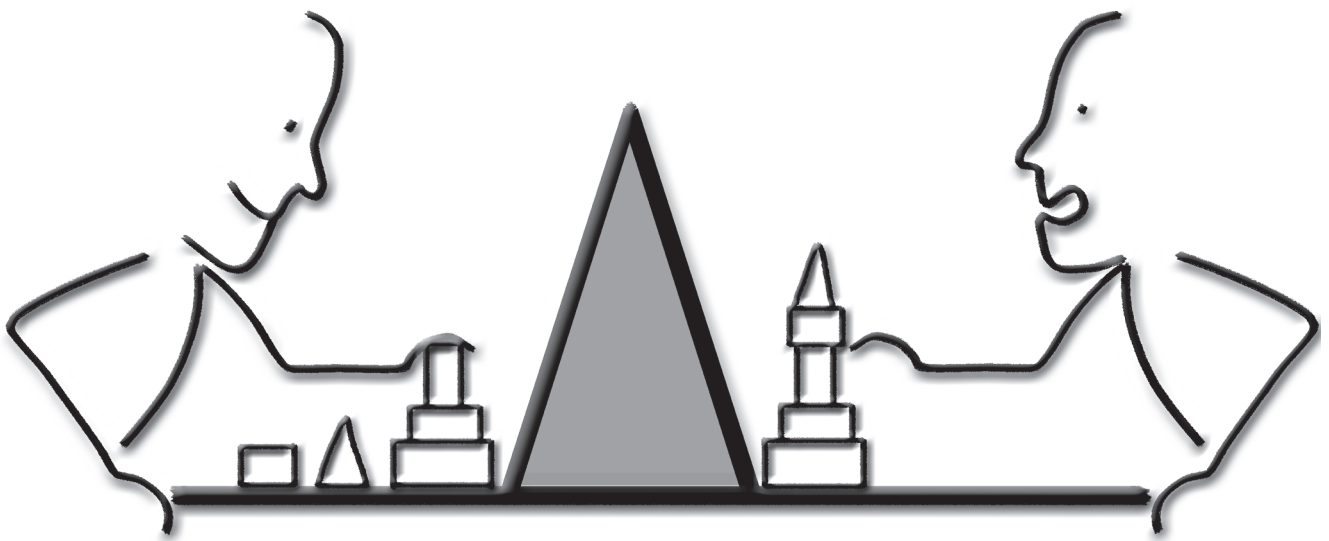

**Over 40 original Barrier Games
with Blackline Masters**

Alison Jarred & Nadja Roelofs



Developing Oral Language
with
BARRIER GAMES

written by
Alison Jarred & Nadja Roelofs

illustrated by
Nadja Roelofs



Text by A. Jarred & N. Roelofs
Illustrations by N. Roelofs

© 2003 Hands On Concepts

Apart from any fair dealing for the purposes of study, research, criticism or review, as permitted under the *Copyright Act*, no part may be reproduced by any process without written permission. Enquires should be made to the publisher at the address below.

Copying for educational purposes

Under the copying provisions of the *Copyright Act*, copies of parts of this book may be made by an educational institution. An agreement exists between the Copyright Agency Limited (CAL) and the relevant educational authority (Department of Education, university, TAFE, etc.) to pay a licence for such copying. It is not necessary to keep records of copying except where the relevant educational authority has undertaken to do so by arrangement with the Copyright Agency Limited.

Published in Australia by
Serles Pty Ltd T/A Hands On Concepts
PO Box 487, Bentley WA 6102, Australia

Contents Page

Introduction

Developing Oral Language	7
Barrier Games	7
Getting Started	8
Barriers	8
Catering for Different Abilities	9

Barrier Games: An Overview **10**

Threading	10
Construction 3D	10
Construction 2D	10
Modelling Clay	10
Draw a Picture	11
Scenes	11
Spot the Difference	11
Shelves and Shapes	12
Maps	12
Grids	12
Coordinates	12
Dressing Up	13
Focus on Words	13

Barrier Game Hints **14**

Identify Game Pieces	14
Rules on Barriers	14
School Set of Barriers	14
Backs as Barriers	14
Children Making Games	14
Using Barrier Games to Link into Writing	14

About Me Barrier Games **15**

Clothes Dress Up	16
Letter Boxes	19
My Room	22
Toy Shop	25
Pet Shop	28
Fruit Shop	30

Contents continued over...

Contents cont...

Fairytales & Fantasy Barrier Games 33

Little Pig Cards	34
Little Pig Spot the Difference	37
Little Pig Lunch	40
Wolf Stew Listen & Draw	43
Dress The Bears	45
Three Bears Spot the Difference	48
Bear Things	51
Fairytale Scene	53
Nursery Rhyme Scene	55
Dragon Map	57
Bunyip Mix & Match	59
Bunyip Brothers	63
Bunyip's Lagoon Spot the Difference	65
At the Lagoon	68
Bunyip's Belly	71
Log Bridge	74
Nuts & Bolts	76
Build-a-Robot	79
Robot Listen & Draw	84
Robot Relatives	86

Animals Barrier Games 88

Farm Animals	89
Farm Number Cards	91
Piggy Pattern Block	93
Jungle Animals	96
Mountain Animals	98
Australian Animals	101
Aussie Animal Pattern Block	103
Fish Number Cards	106
Treasure on the Beach	108
Sea Creatures	110
Spotted Caterpillar	113
Number Butterflies	115
Dinosaur Land	118
Dinosaurs	120

Grid Barrier Games 123

Grids	124
-------	-----

Introduction

Developing Oral Language

Oral Language underpins the development of other language skills such as reading and writing. By focusing on activities which develop oral language skills, children learn to manipulate and control language to suit their purpose. Barrier Games are a great oral language tool as they provide opportunity to develop skills for both speaking (composing) and listening (reception/comprehension).

Barrier Games

Barrier Games have been in existence for many years, and include games which require players to give and receive directions while being separated by some kind of barrier. A common barrier game many of us will have played is *Battleships*, a hit/miss game using coordinates.

Barrier games are a flexible teaching tool which can easily be adapted to cater for a wide range of ages and abilities. The complexity of the language used will depend on the task. The games can range from simple sequencing of coloured counters to giving lengthy instructions for locating objects in a detailed scene.

Barrier games also provide opportunities for developing and assessing children's oral language skills. Players need to interact and use language to play the game. By monitoring children's language, you will gain many insights into how they give and receive instructions. Careful listening is necessary to follow directions when playing barrier games. Listeners need to monitor the information they receive and ask questions to clarify or get more information. As children grow more experienced at playing barrier games, they show evidence of planning and sequencing the directions they give. Children begin to anticipate what the listener might need to know and their directions become more complete and explicit.

An important part of the game is the stage where the barrier is removed and players check the placement of the pieces. At this time children should be encouraged to reflect on any differences that occurred and any problems they may have had. Solutions to common problems could be brainstormed and role-modelled with the whole class.

Getting Started

When teaching children how to play a barrier game, choose a partner and play the game while the rest of the class observes. This “modelling” approach is useful for explaining:

- *how to set up the game*

This includes how to position the barrier so that you can't see the other player's game pieces and how to sort the playing pieces so that they are all visible, the right way up and easy to find. In games with multiple pieces, it will be useful to sort the pieces into groups according to colour, shape, type of kind of object, etc.

Note: Young children may find it easier to sit beside each other with the barrier between them rather than sitting opposite. This can avoid lateral problems, particularly when the barrier is removed and children are checking their work.

- *rules of playing*

This includes speaking and listening courtesies, such as asking the other player if they are ready before giving directions. Remind children about the “no looking” rule as it is very tempting to look over the barrier. It is also important that the player giving the direction also follows the direction themselves so that the game items “match” when the barrier is taken away.

- *language use*

Model any specific language needed. Most barrier games use vocabulary associated with nouns (the names of items), attributes (their size, shape, colour etc.) and location (where they are to be placed, e.g. top, bottom, near to, etc.) also model how to ask questions when you need more information.

- *how to end the game*

Demonstrate how to remove the barrier and compare the game pieces before packing them away. Model how to reflect on why differences may have occurred.

Barriers

Create barriers using large hard-cover books opened on the desk, or fold thick cardboard in half with some knotted string through one side. Larger barriers for group games can be created using room dividers, cupboards or even a desk tipped on its side.

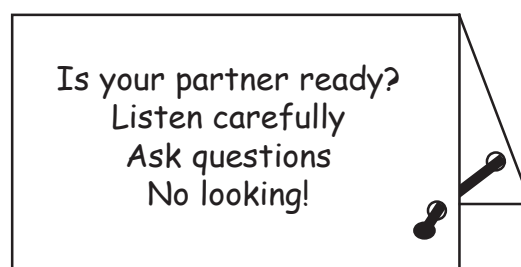

Catering for Different Abilities

Most barrier games are very adaptable and can be easily modified to suit a range of abilities. When introducing a new style of barrier game, it is often useful to play it in a simpler way and then increase the difficulty as players become more skilled. In general, factors which effect difficulty include:

- *number of items*

Reduce the number of items to reduce the difficulty of the game.

- *attributes*

Consider the number of attributes required to describe an item. Colour is the easiest attribute to identify. As you combine more attributes, e.g. colour, size, shape, pattern and texture, the game becomes more challenging.

- *item similarity/difference*

To reduce the difficulty, start with a range of items that are quite different and easy to identify. The more similar the items, the more careful the description has to be in order to differentiate between them.

- *language*

Consider the players familiarity with the names of items. Players need to have a common language for naming and describing items. This is where prior modelling and opportunities to sort and describe items before playing can be important.

- *number of players*

Paired Barrier Games: The most common barrier game is played between two players with a barrier between them. This style of play is most successful between players of similar language ability.

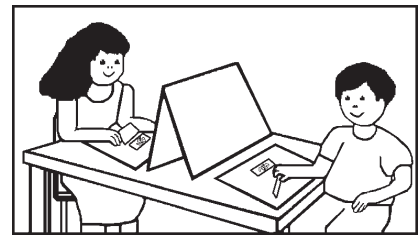

Buddy Barrier Games: Younger children often benefit from playing Buddy Barrier Games, where two children are on each side of the barrier. This allows pairings of weaker and more able language users together to provide peer modelling and support. Buddies can either take turns at giving and receiving directions or the more able language user may give (speak) the direction while the weaker language user receives (listens).

Group Barrier Games: Whole class or small group barrier games also provide peer modelling and support and can often be logistically easier to organise. These can be played as “one-to-many” or “group vs group”. One-to-many is played by one player (who can not be seen) giving directions to the whole group. Group vs group is played where groups are separated by a barrier (room divider, free standing chalkboard, etc) and a player from each group takes a turn at giving and receiving a direction before being replaced by the next member of the group.

Barrier Games: An Overview

Threading

Use beads, buttons, cut straws, coloured macaroni, or anything threadable plus something to thread the items onto, e.g. fishing line, needle and wool, thin plastic tube, etc. If you can create several identical sets of materials, this also works successfully as a group barrier game, i.e. one player hides behind a barrier and gives instructions to remaining members of the group.

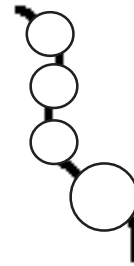

Construction 3D

Use blocks, commercial construction kits, Unifix® cubes, junk materials, etc. You will need two identical sets of materials. Games could be played as “collaborative construction” or “copy the model”. To play “**collaborative construction**”, players would take turns to select an item and describe how to join it to the growing construction in front of each player. To play “**copy the model**”, one player would build a construction and then instruct their fellow player on how to build a copy. The greater the number of items and shape, size and colour variation of the materials, the more difficult the game will be.

Construction 2D

Use cut-out shapes, pictures, attribute blocks, pattern blocks, etc. You will need two identical sets of materials. Players can take turns using items to assemble a picture or a pattern. As above for Construction 3D, the games could be played as “collaborative construction” or “copy the model”. Examples in this book include:

- Build-a-Robot p.79
- Piggy Pattern Block p.93
- Aussie Animal Pattern Block p.103

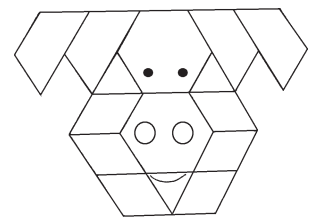

Modelling Clay

Use clay, play dough, plastercine or similar. One player creates a model and describes the shapes and sizes of the parts to the other player, who tries to replicate the model.

Draw a Picture

Use paper, chalkboard, whiteboard, etc with identical sets of drawing materials. Each player takes turns to add something to the scene and describe it to their fellow player, e.g. *“Draw three blue shells on the bottom right corner of the page.”*

Note: For younger or less able players, adding to a partially drawn scene is easier than starting from a blank page. This style of barrier game is also quite successful as a “group vs group” barrier game as described on p.3. Examples in this book include:

- Wolf Stew Listen & Draw p.43
- Robot Listen & Draw p.84

Scenes

Use duplicate scenes (blackline or coloured) in combination with identical sets of coloured pencils, counters, objects, pictures, etc. (Some gift wrapping papers have scenes which make excellent barrier games.) Games can locate items on the scene or add items to the scene. On a busy scene, locating items often works best as the focus is on the scene detail.



Players could colour or mark an item with a coloured pencil, e.g. *“Colour the crocodile green.”* or place a coloured counter onto the item, e.g. *“Put a red counter on the tiger’s head.”* On a simple scene the focus may be on the items being added such as a selection of cutout pictures, e.g. *“Put the green bird near the butterfly.”* or additional items could be drawn on a scene, e.g. *“Draw a yellow bird beside the monkey.”*

Examples in this book include:

- Letter Boxes p.19
- Fairytale Scene p.53
- Nursery Rhyme Scene p.55
- At the Lagoon p.68
- Farm Animals p.89
- Jungle Animals p.96
- Mountain Animals p.98
- Australian Animals p.101
- Sea Creatures p.110
- Dinosaurs p.120

Spot the Difference

Use two scenes which have been altered to include several differences. Players take turns to describe an area of the scene. By listening carefully and asking questions, players try to discover where the scenes are different and mark these places with a pencil or with by placing a counter on the area. This is quite challenging and is also successful as a group barrier game. Examples include:

- Little Pig Spot the Difference p.37
- Three Bears Spot the Difference p.48
- Bunyip’s Lagoon Spot the Difference p.65

Shelves and Shops

Use drawn or real shelves with cut out pictures or real items. Using shelves focuses language on position concepts such as top, middle, bottom or first shelf, second shelf, third shelf, etc. Players take turns to give instructions for placing items on the shelves. Examples include:

- Toy Shop p.25
- Pet Shop p.28
- Fruit Shop p.30

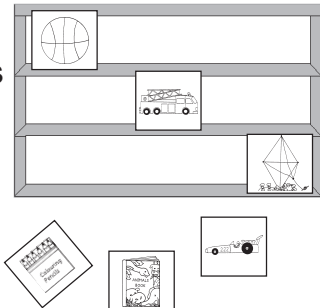

Maps

Use duplicate copies of a map with coloured pencils/pens or copy the map onto clear acetate (OHP) sheets and reuse them with soluble pens. Maps can include: classroom plans, school grounds, house plans, shopping centres, local area maps, city streets, state road maps, atlas maps, treasure maps, etc. One player gives directions (while drawing on their own map) and their fellow players listens and marks the route on their map. Change coloured pencils to mark a new route with each player turn.

Grids

Use grids with picture cards, word cards, number cards or objects. To simplify grid use, colour the boxes differently so that players can refer to the colour name to place the card on the grid, e.g. *“Place the three pigs card on the red box.”* For more able players, encourage the naming of position and row to identify the area on the grid. There are many variations possible. Grids could also contain sight vocabulary words, letters, blends, numbers or anything you wish children to identify and name, e.g.

“Place the red block on the word house.” Examples include:

- Little Pigs Cards p.34
- Bear Things p.51
- Bunyip Brothers p.63
- Robot Relatives p.86
- Fish Number Cards p.106
- Number Butterflies p.115
- Grids p.123

Coordinates

Use grids with coordinates over a scene or map to assist players to place or locate items. This can be used for games like Treasure maps where players mark the treasure on the map then take turns to guess the coordinate location, e.g. *“Is the treasure at D 6?”* Examples include:

- Dragon Map p.57
- Dinosaur Land p.118



Dressing Up

Use real clothes, dolls with identical clothes, or cardboard models with paper clothing. Players can take turns to add on an item of clothing or one player could give all the directions. This game is easy to adapt to a range of abilities by including attributes such as colour, size, pattern and number. Examples include:

- Clothes Dress Up p.16
- Dress the Bears p.45

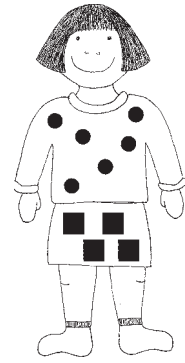

Focus on Words

Use identical copies of a word list with some coloured pencils. Players take turns to describe a word without naming the word, e.g. *“Place a red line under the word that has 6 letters and begins with the /ch/ sound.”* Alternatively in a group barrier game of the style one-to-many (described on p.9), one player circles a word without showing the group, then group players take turns to ask questions to identify the word, e.g. *“Does the word end with ing?”* See Grids p.123 for further ideas.

Barrier Game Hints

Identify Game Pieces

For games with many pieces, a quick way of sorting or identifying odd pieces is to mark the back of each set of pieces in a similar way, e.g.

- write Set A, Set B, etc on each set
- place a coloured sticker on each set
- draw a different symbol on each set

Rules on Barriers

To assist players to remember the common rules, paste a copy on each side of the barrier.

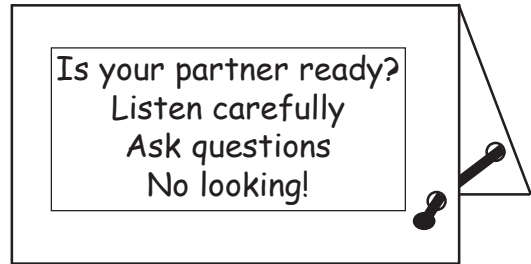

School Set of Barriers

Consider making a school set of barriers created from folding thick cardboard and knotting string. A set of 15 barriers stored in a box can service a class of 30 children.

Backs as Barriers

For some barrier games such as pattern block descriptions, word lists or spot-the-difference scenes, try using a child's back as a barrier. Children sit one behind the other (facing the same direction) the scene or picture is pinned onto the back of the front child. The front child has their own scene or blocks in front of them and receives directions from the child behind.

Children Making Games

To save teacher preparation time for games which require the cutting out of many pieces, consider having children prepare the pieces for the game in a prior lesson.

Using Barrier Games to Link into Writing

After playing a barrier game several times, extend its usefulness by using it for a writing activity. Have children paste the items into position and then write a description to match.

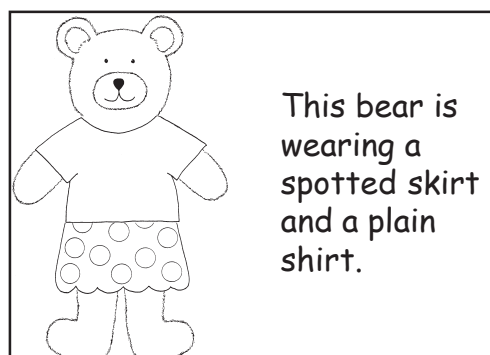

About Me Barrier Games

Clothes Dress Up

Focus Areas

- language: names of clothes
- attributes: colour and pattern
- number conservation

Preparation

- Make duplicate copies of Clothes 1 & 2.
Note: Copy onto light card to create a sturdier set of pieces.
- Cut out dolls and clothes.
Tip: Mark backs of each clothes and doll set differently for easy sorting.

Suggested Use

1. Place a barrier between players. Players on each side of the barrier have:
 - a boy and girl doll
 - a set of clothes
2. One player dresses the dolls giving instructions to the other player who then dresses the same dolls in identical clothes.
3. The barrier is removed and the dolls are compared. Players note any differences.
4. The barrier is replaced and the game proceeds with the other player dressing the dolls and giving instructions.

Variations

- **Colour** Copy the clothes onto coloured paper or light card to create coloured sets of clothes. *“Find the red shoes.”*
- **Shape** Add shapes to the clothes. Make sets with different shapes, e.g. circles, squares and triangles. *“Find the shorts with triangles.”*
- **Number** Add different numbers of shapes to sets of clothes. *“Find the shirt with 5 circles.”*
- **Addition** Modify the barrier game with a number rule, e.g. All dolls must be dressed to equal 10. Players must then choose combinations of clothes with shapes that total 10. *“Find the shirt with 4 squares and the sweater with 6 circles.”*
- **Size** Use the photocopier to enlarge or reduce a set of dolls and clothes so that players choose between different sizes. *“Find the large boots.”*

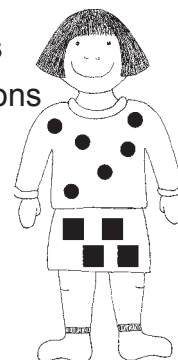

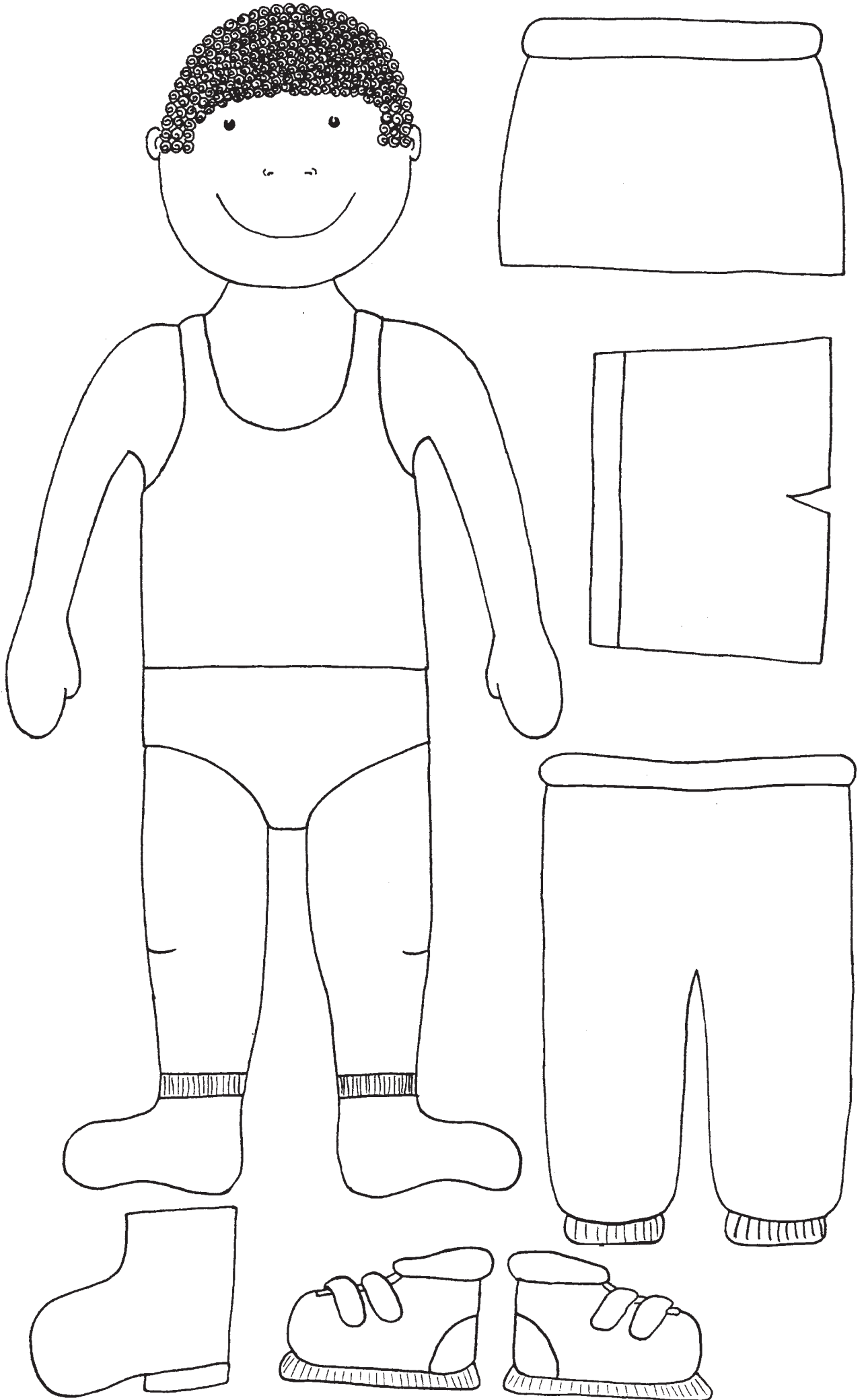

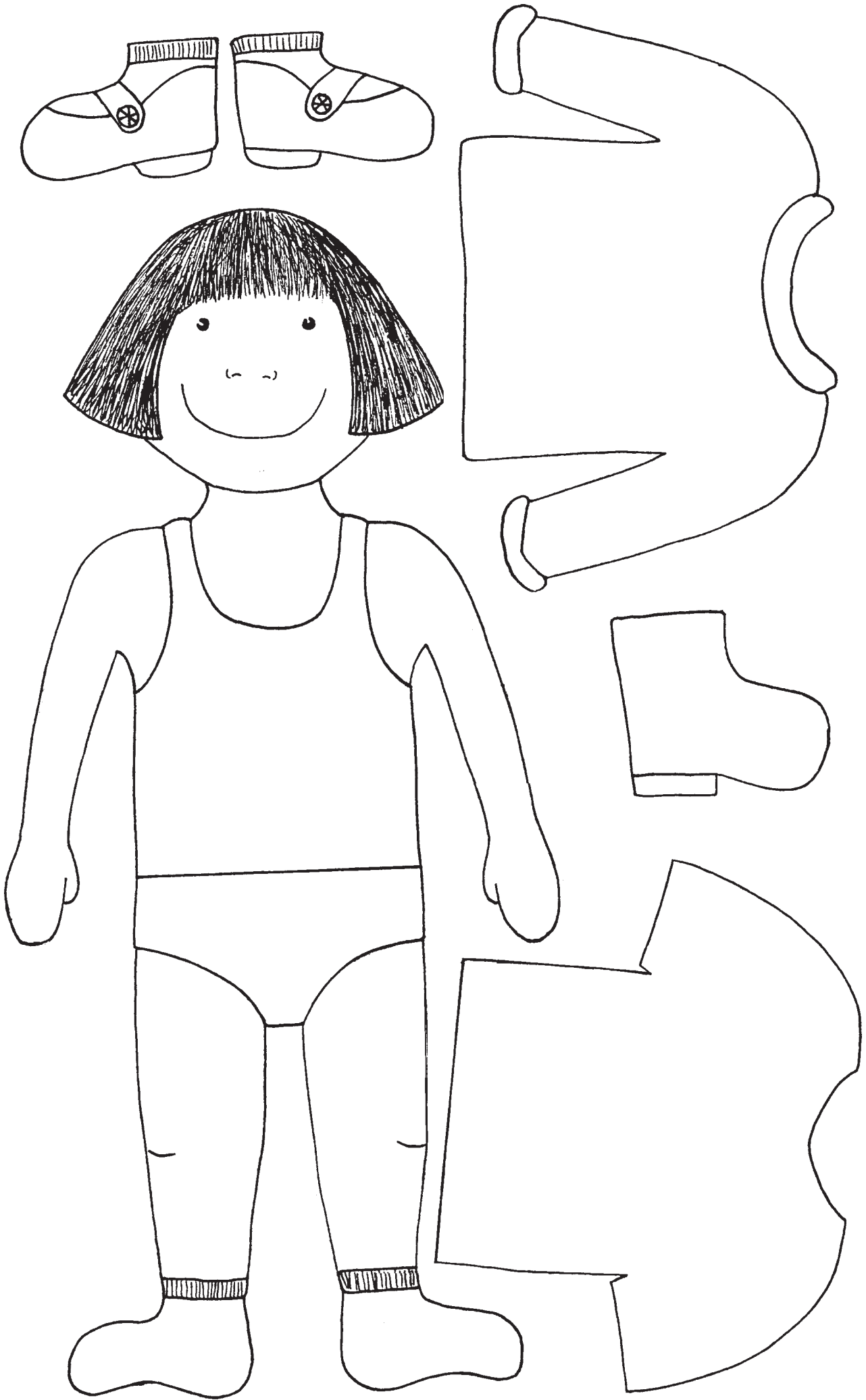

Letter Boxes

Focus Areas

- language: description
- position concepts

Preparation

- Enlarge to A3 and make duplicate copies of Houses.
- Make duplicate copies of plain and or numbered letterboxes.
- Cut out letterboxes.
Tip: Mark backs of each letterbox set differently for easy sorting.

Suggested Use

1. Place a barrier between players. Players on each side of the barrier have:
 - a house scene
 - a set of letterboxes (shaped or numbered)
2. Players take turns to select a letterbox and place it in front of a house, describing both the letterbox and the house to the other player so they can copy the action. *“Place the round letterbox in front of the house that has a fence and smoke coming out of the chimney.”*
3. When all houses have a letterbox the barrier is removed and the house scenes are compared. Players note any differences.

Variations

- **Colour** Colour the letterboxes in a range of colours. *“Place the red letterbox in front of the house with no fence, a triangle roof and flowers.”*
- **Number** Add different numbers to the letterboxes to focus on number recognition.

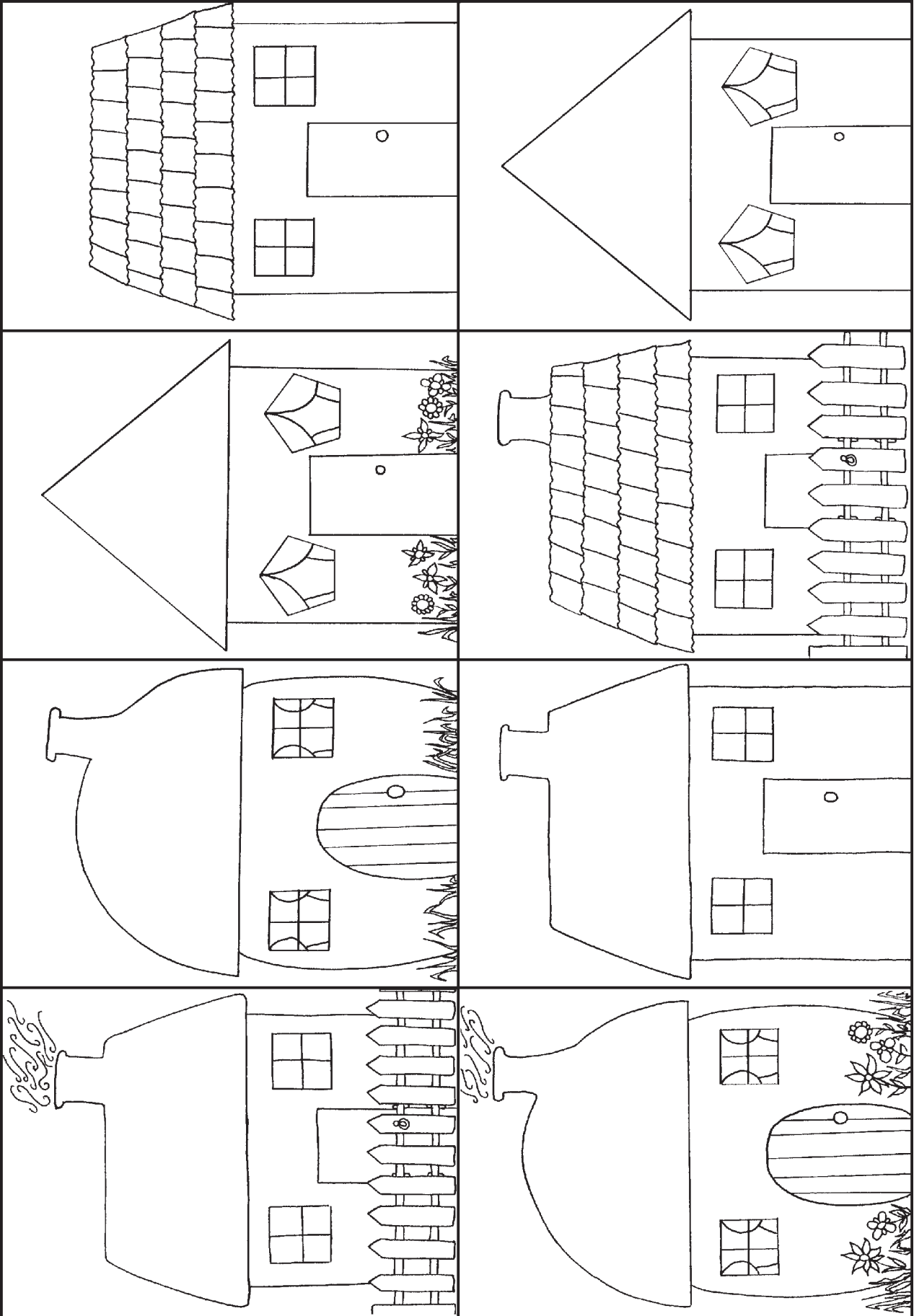

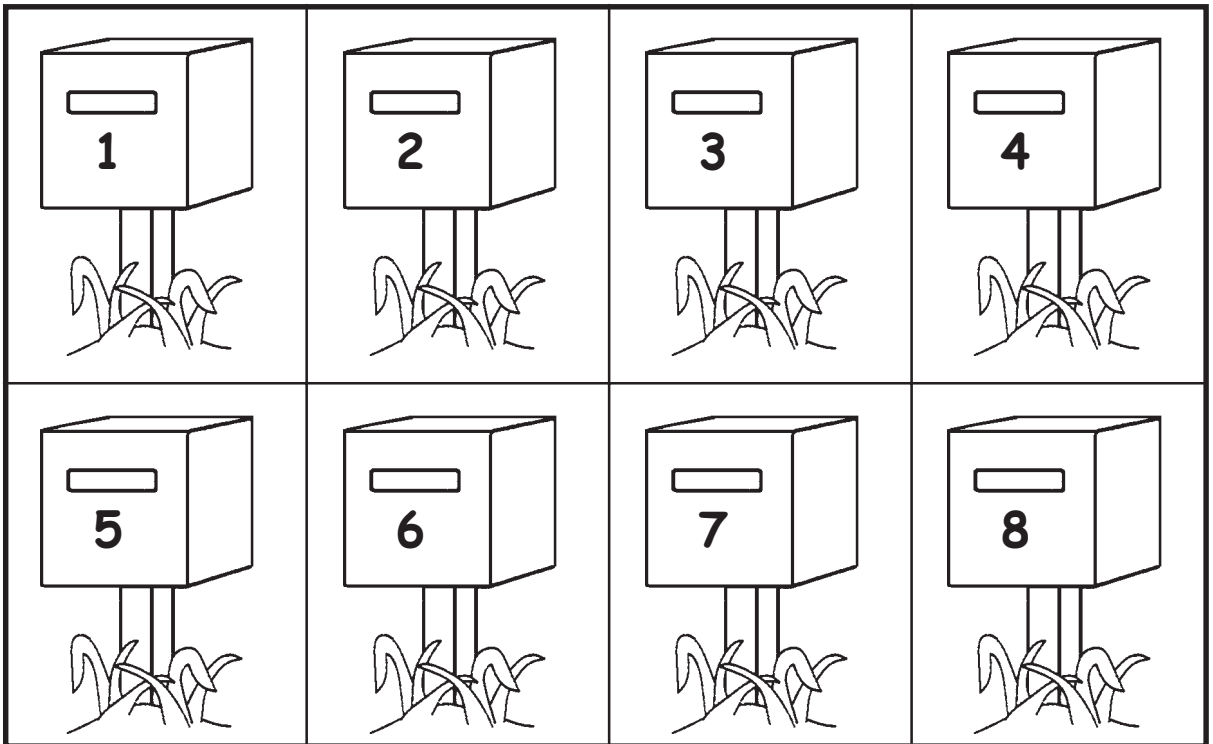
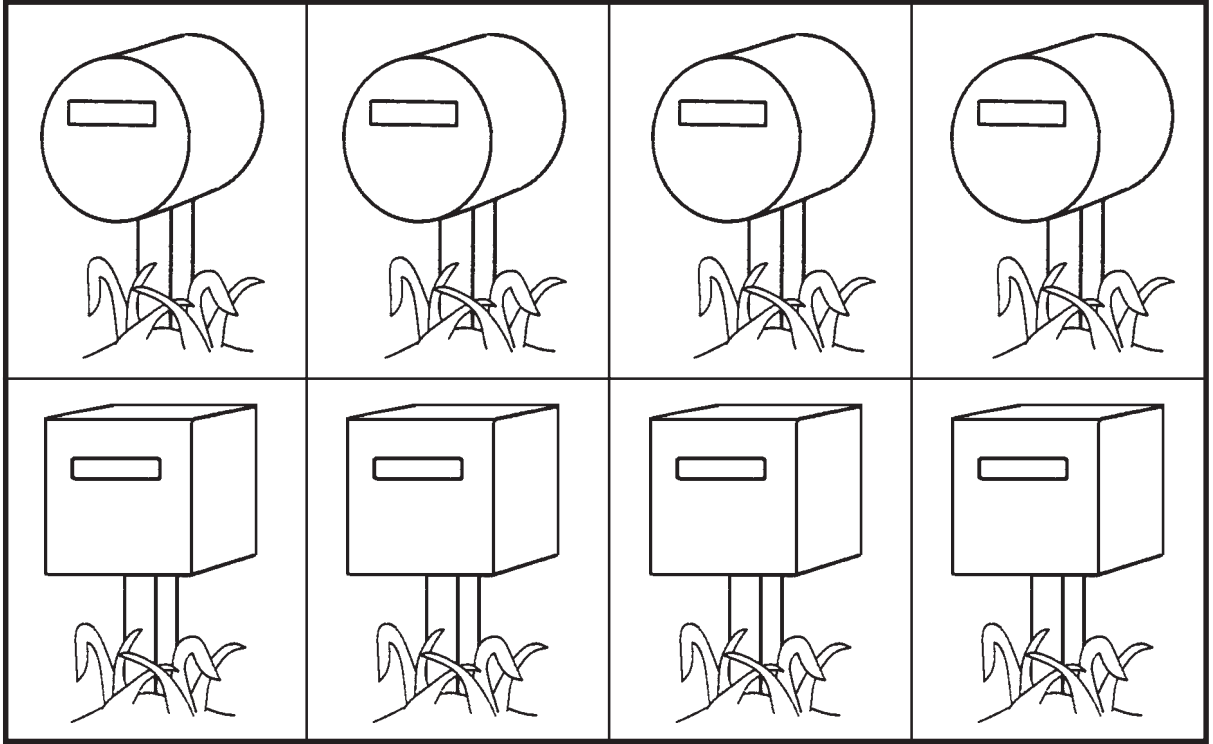

My Room

Focus Areas

- language: description
- spatial concepts

Preparation

- Copy My Room 1 & 2

Suggested Use

1. Place a barrier between players. You need:
 - a copy of scenes My Room 1 and My Room 2
 - pencils
2. One Player is given Room 1 and the other player is given Room 2.
3. Players take turns to describe or ask questions about the scene to find where the differences are, e.g. *"I can see a butterfly with spotted wings. Can you?"*
4. Players mark any differences they discover with the pencil.
5. Play continues for a set period of time or until the players have found all the differences.
6. The barrier is then removed and the players compare scenes to check if any items were missed.



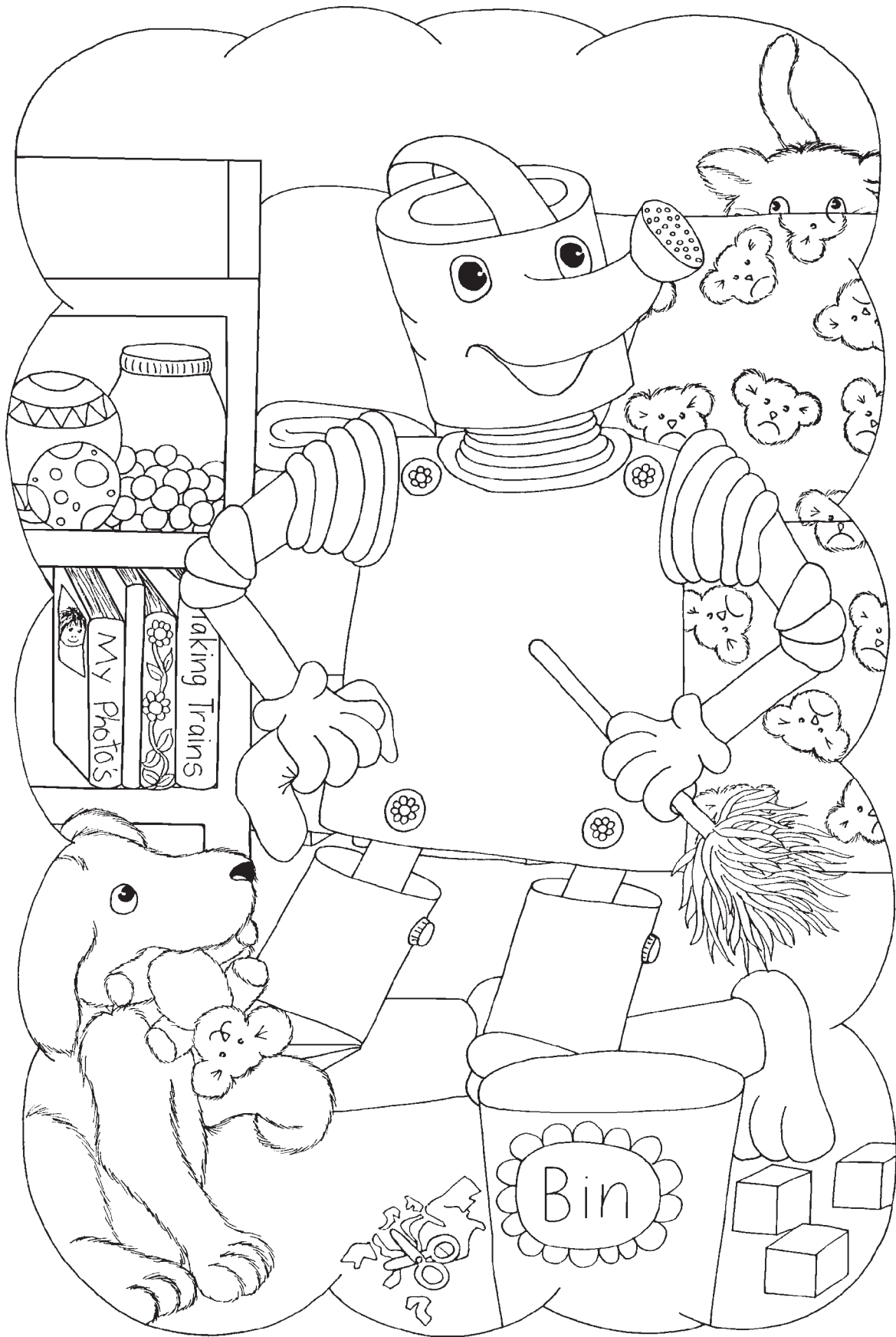

Toy Shop

Focus Areas

- language: names of toys
- position concepts: top, middle, bottom, left, right

Preparation

- Enlarge to A3 and make duplicate copies of Shop Shelves.
- Make duplicate copies of the Toys.
- Cut out Toy cards.
Tip: Mark backs of each toy card set differently for easy sorting.

Suggested Use

1. Place a barrier between players. Players on each side of the barrier have:
 - a shop shelves
 - a set of toy cards
2. Players take turns to select a toy and place it on a toy shop shelf while giving directions to the other player so they can place the same toy in the same position, e.g. *“Place the book on the top shelf closest to the left side.”*
3. Players continue until all the toys are placed or until both players have had several turns at giving and receiving directions.
4. The barrier is then removed and the toy shops are compared. Players note any differences that occurred.

Variations

Number Duplicate several sets of toy cards until there are multiple copies of each toy. Players can then give instructions which include number, e.g. *“Place 4 cars on the middle shelf.”*

Colour Color the toys or copy the toy card sets onto coloured paper. Players then need to include colour as an attribute when selecting a toy, e.g. *“Place the blue ball on the bottom shelf to the right of the yellow kite.”*

Simplify Shelves Lightly colour each shelf background a different colour to aid differentiation between shelves.

Left & Right Cues Mark “L” on the left side of the shelves and “R” on the right to assist children to identify positions more easily.

Enlarge to A3 size when copying

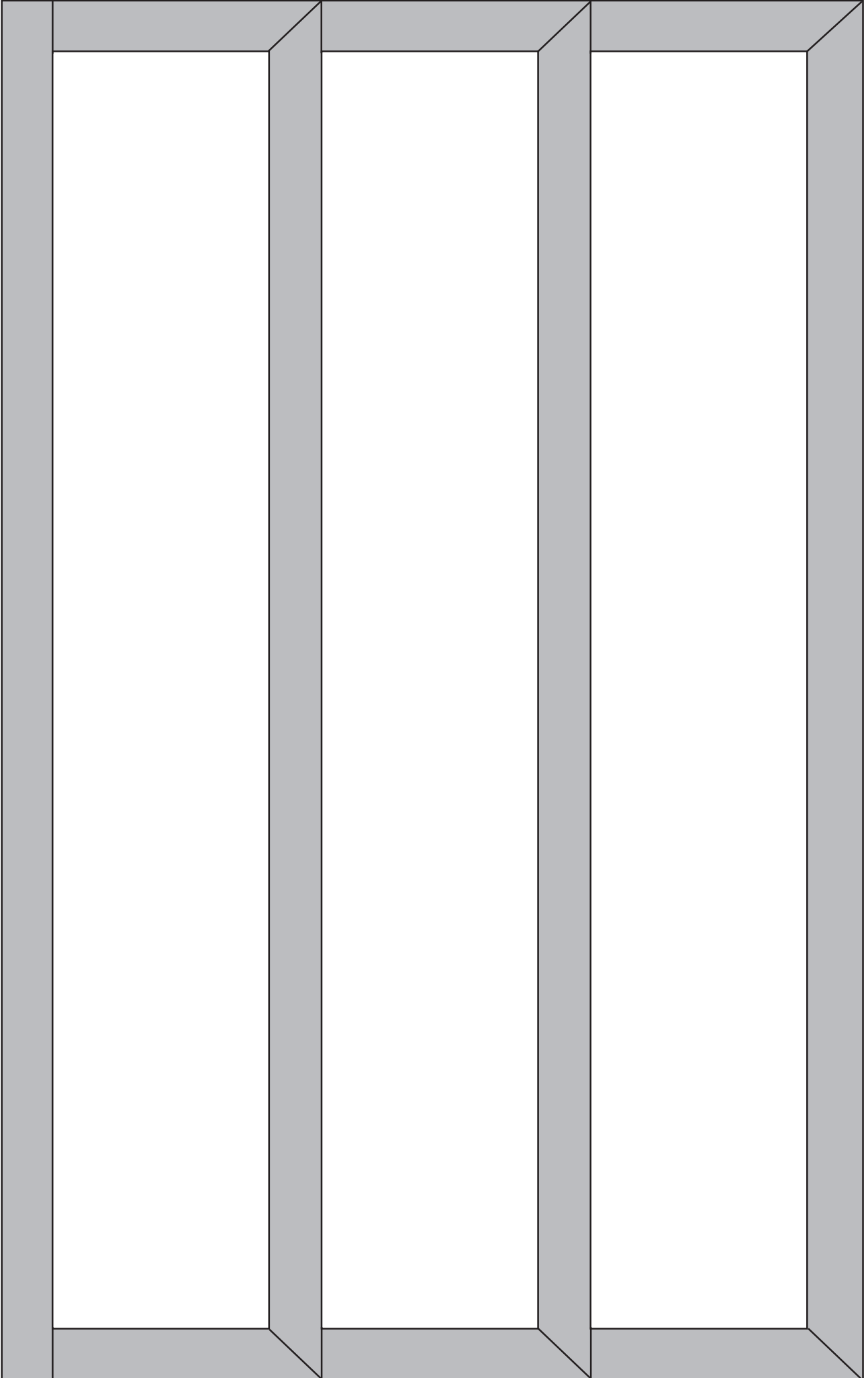

Shop Shelves

© 2003 Hands On Concepts

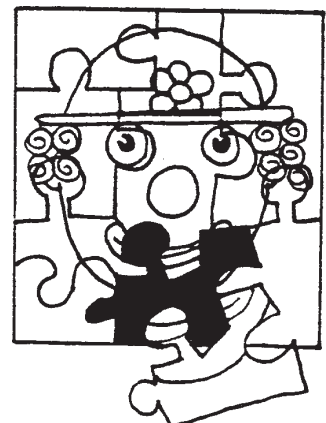
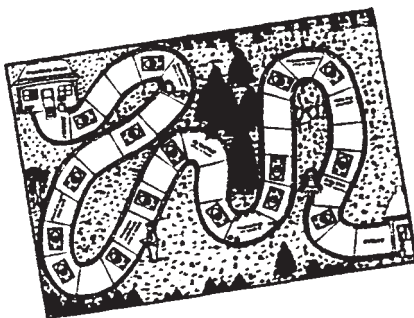
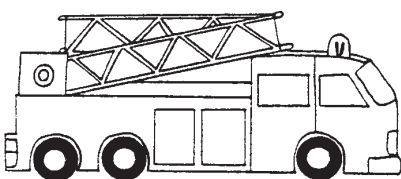
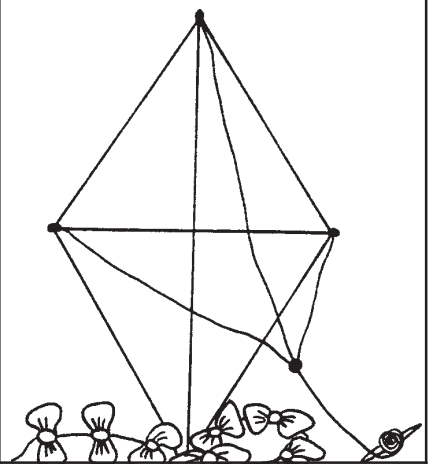
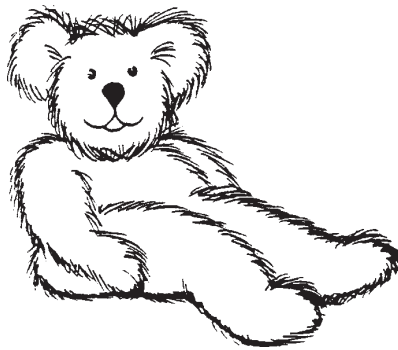
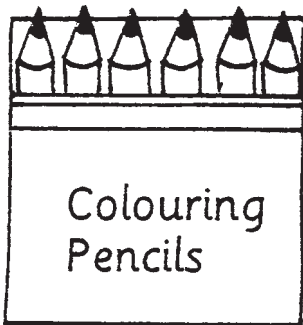
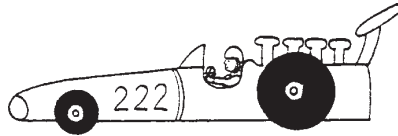
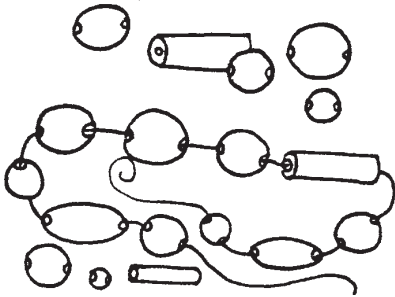
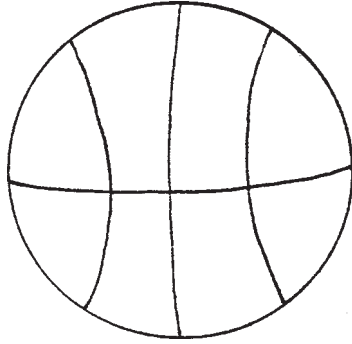

Pet Shop

Focus Areas

- language: names of pets
- position concepts: top, middle, bottom, left, right

Preparation

- Enlarge to A3 and make duplicate copies of Shop Shelves. (Use shelves p.26)
- Make duplicate copies of the Pets.
- Cut out Pet cards.

Tip: Mark backs of each pet card set differently for easy sorting.

Suggested Use

1. Place a barrier between players. Players on each side of the barrier have:
 - a shop shelves
 - a set of pet cards
2. Players take turns to select a pet and place it on a shop shelf while giving directions to the other player so they can place the same pet in the same position, e.g. *“Place the cat on the top shelf on the right side.”*
3. Players continue until all the pets are placed.
4. The barrier is then removed and the shops are compared. Players note any differences that occurred.

Variations

Number Duplicate several sets of pet cards until there are multiple copies of each toy. Players can then give instructions which include number, e.g. *“Place 3 turtles on the middle shelf.”*

Simplify Shelves Lightly colour each shelf background a different colour to aid differentiation between shelves.

Left & Right Cues Mark “L” on the left side of the shelves and “R” on the right to assist children to identify positions more easily.

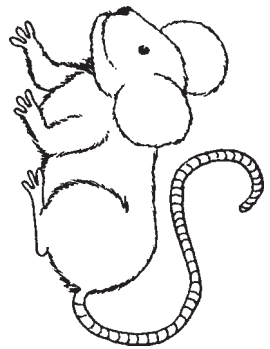
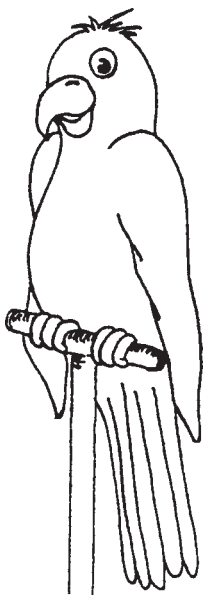
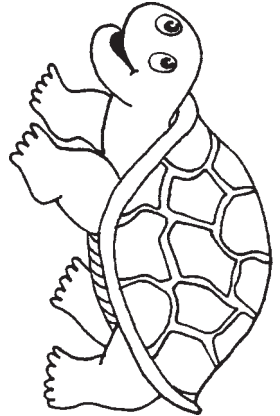
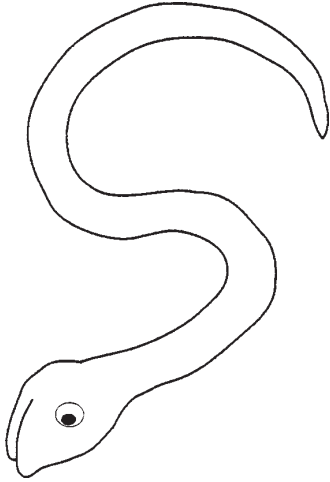
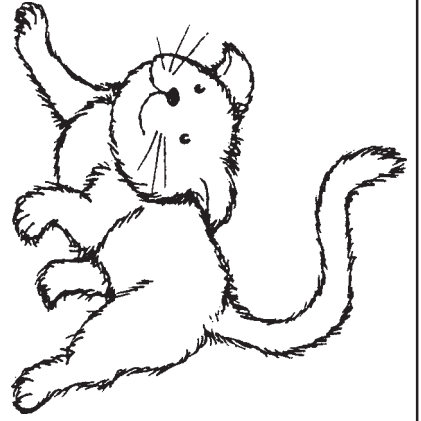
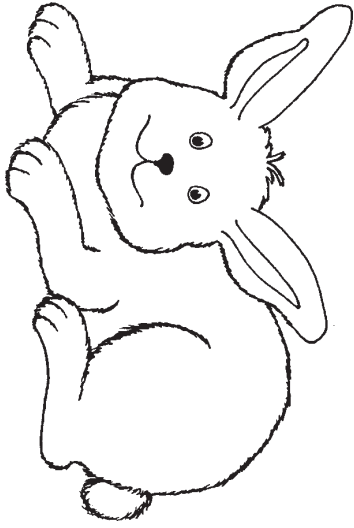
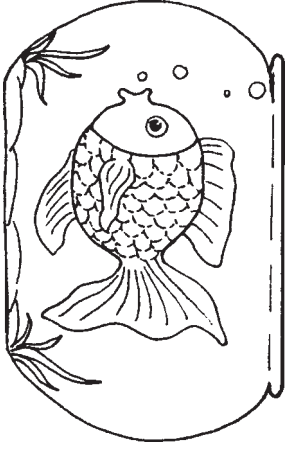

Fruit Shop

Focus Areas

- language: names of fruit
- number: counting
- position concepts: top, middle, bottom, left, right

Preparation

- Enlarge to A3 and make duplicate copies of Shop Shelves. (Use shelves p.26)
- Make duplicate copies of the Fruit 1 & 2.
- Cut out Fruit cards.

Tip: Mark backs of each fruit card set differently for easy sorting.

Suggested Use

1. Place a barrier between players. Players on each side of the barrier have:
 - a shop shelves
 - a set of fruit cards
2. Players may wish to sort the fruit cards before starting in order to make them easy to locate, e.g. sort by type of fruit or by number.
3. Players take turns to select a fruit card and place it on a shop shelf while giving directions to the other player so they can place the same card in the same position, e.g. *“Place the card with 6 cherries on the right side of the bottom shelf.”*
4. Players continue until all the shelves are filled.
5. The barrier is then removed and the fruit shops are compared. Players note any differences that occurred.

Variations

Addition Set a number limit for each shelf, e.g. 10 items of fruit. Players need to calculate how many pieces of fruit are on the shelf when adding another card to ensure each self adds up to 10.

Simplify Shelves Lightly colour each shelf background a different colour to aid differentiation between shelves.

Left & Right Cues Mark “L” on the left side of the shelves and “R” on the right to assist children to identify positions more easily.

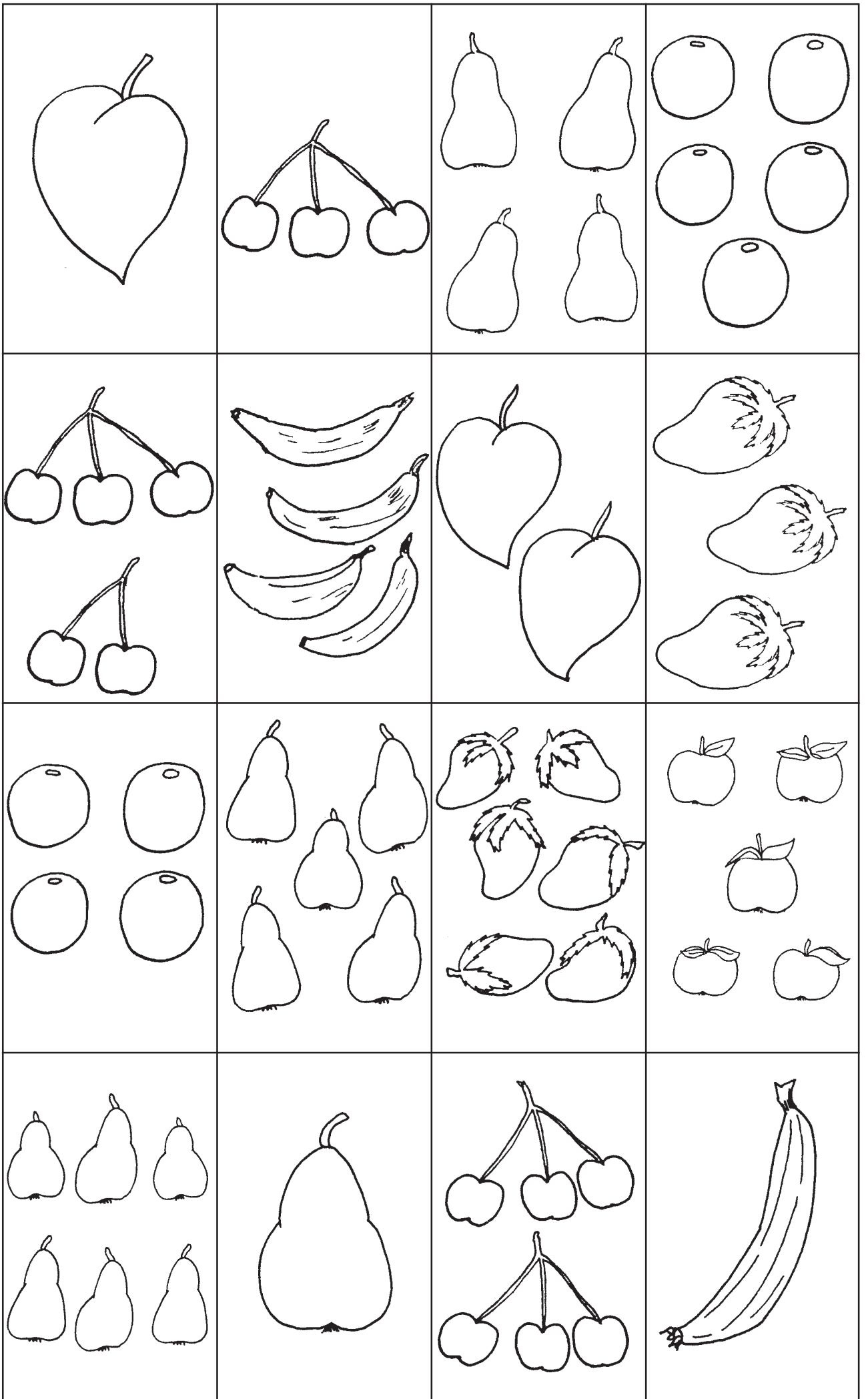

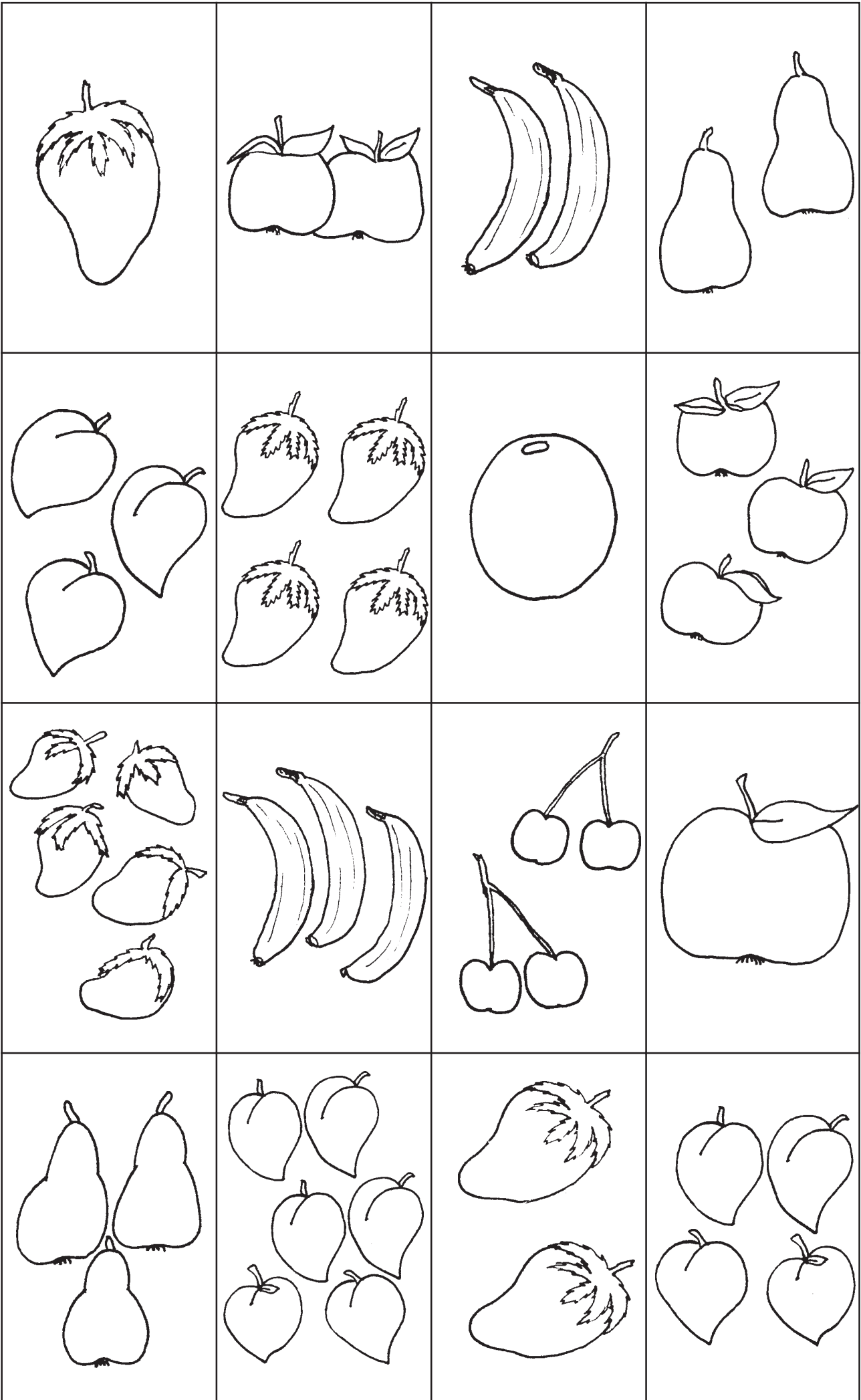

Fairytales & Fantasy Barrier Games

Little Pig Cards

Focus Areas

- language: description
- number: counting
- position concepts: facing left, facing right, row, position

Preparation

- Enlarge to A3 and make duplicate copies of 6 or 12 Grid. (See Grids p.125-6)
- Make duplicate copies of the Pigs 1 & 2.
- Cut out Pig cards.

Tip: Mark backs of each pig card set differently for easy sorting.

Suggested Use

1. Place a barrier between players. Players on each side of the barrier have:
 - a grid
 - a set of pig cards
2. Players may wish to sort the pig cards before starting in order to make them easy to locate.
3. Players take turns to select a pig card and place it on grid while giving directions to the other player so they can place the same card in the same position, e.g. *“Place the 2 pigs with straw in row 1, position 3.”*
4. Players continue until all the grid areas are filled.
5. The barrier is then removed and the grids are compared. Players note any differences that occurred.

Variations

Colour Grid To simplify the placement of cards, colour each area on the grid with a different colour, e.g. *“Place the pig waving on the red box.”*

Word Grid To practise the identification of sight vocabulary, place words on the grid, e.g. *“Place the pig with flowers on the word, house.”*

pig	house	stick
straw	wolf	brick

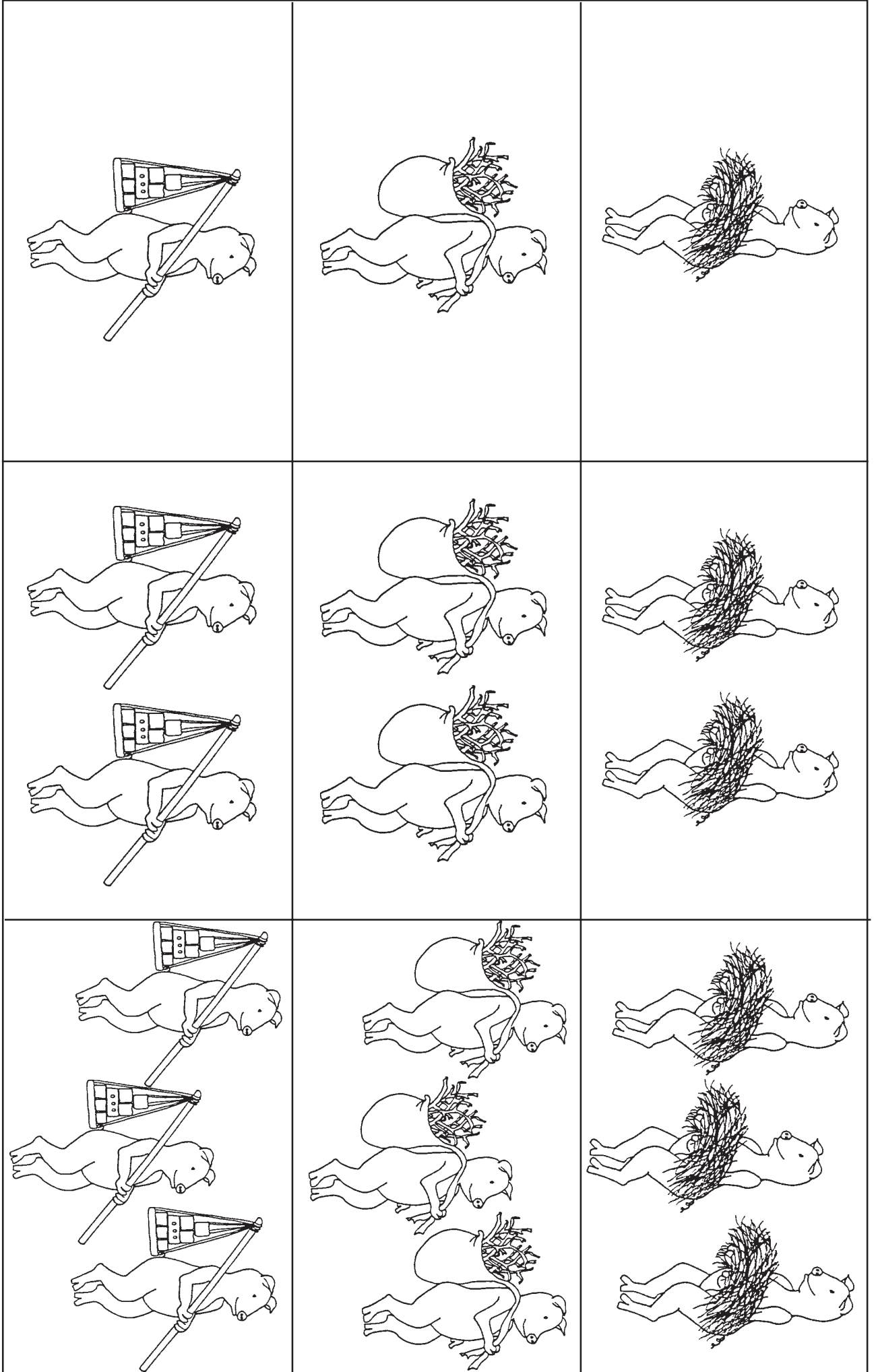

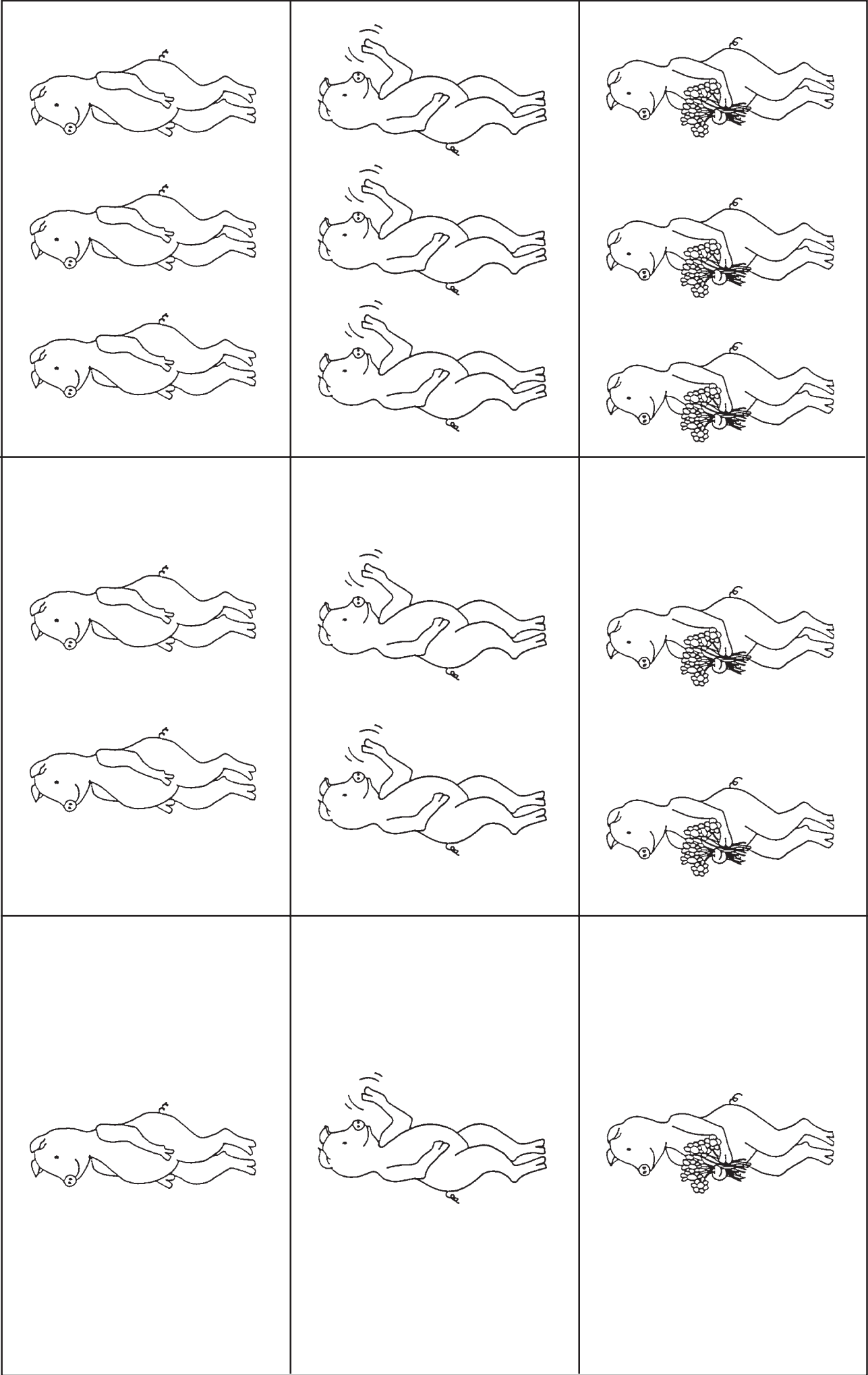

Little Pig

Spot the Difference

Focus Areas

- language: description
- spatial concepts

Preparation

- Copy Pig Scene 1 & 2

Suggested Use

1. Place a barrier between players. You need:
 - a copy of Pig Scene 1 & Pig Scene 2
 - pencils
2. One Player is given Pig Scene 1 and the other player is given Pig Scene 2.
3. Players take turns to describe or ask questions about the scene to find where the differences are, e.g. *"I can see 5 bees above the house. Can you?"*
4. Players mark any differences they discover with the pencil.
5. Play continues for a set period of time or until the players have found all the differences.
6. The barrier is then removed and the players compare scenes to check if any items were missed.





Little Pig's Lunch

Focus Areas

- language: names of food
- number: counting

Preparation

- Make duplicate copies of Little Pig.
- Make duplicate copies of Food.
- Cut out Food cards.

Tip: Mark backs of each food card set differently for easy sorting.

Suggested Use

1. Place a barrier between players. Players on each side of the barrier have:
 - a little pig
 - a set of food cards
2. Players may wish to sort the food cards before starting in order to make them easy to locate.
3. One player places a selection of food items into little pig's bag while giving directions to the other player to do the same, e.g. *"Place the 6 apples and 3 cupcakes with single cherries into the bag."*
4. The barrier is then removed and the little pig's bags are compared. Players note any differences that occurred.
5. The other player then has a turn to place food items into the bag and give directions.

Variations

Bag Limit Set a total number for little pig's bag, e.g. 15 items. Players then place a combination of food items into the bag to equal the total limit.

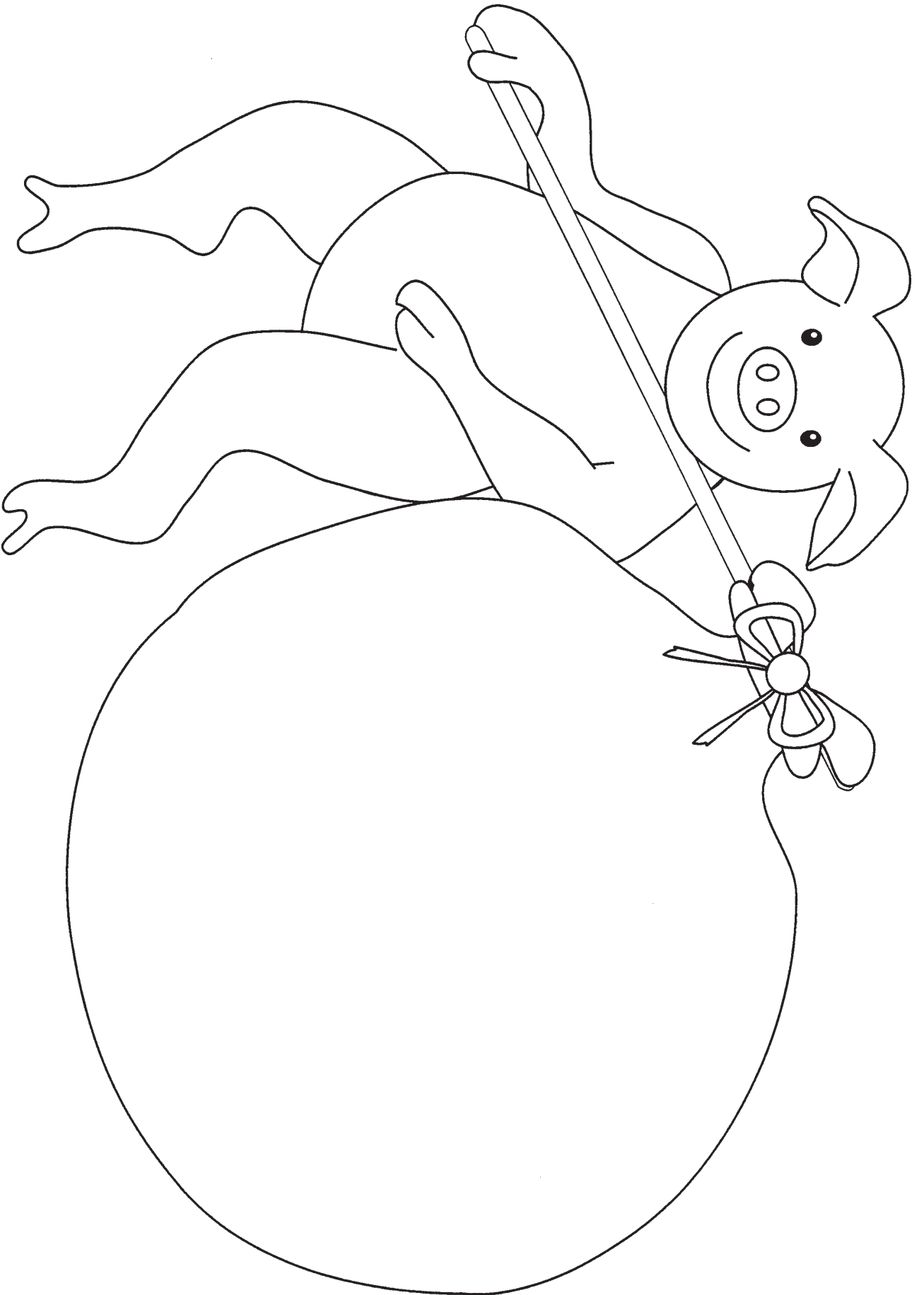

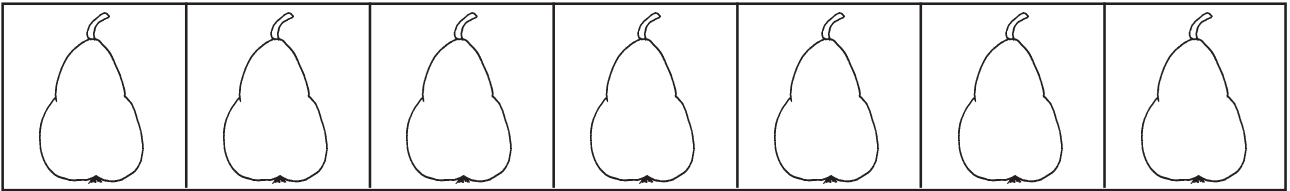
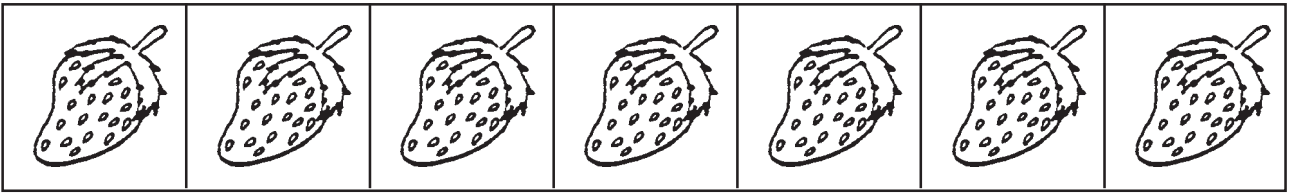
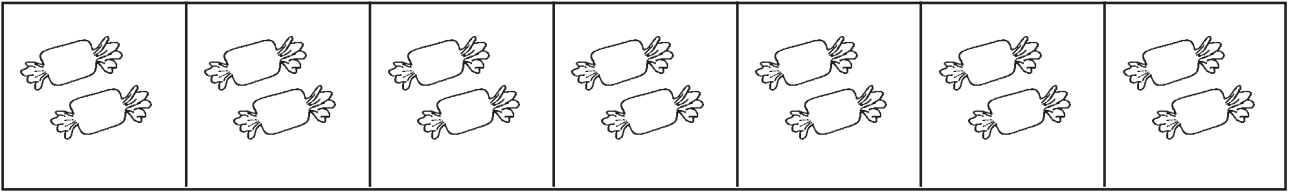
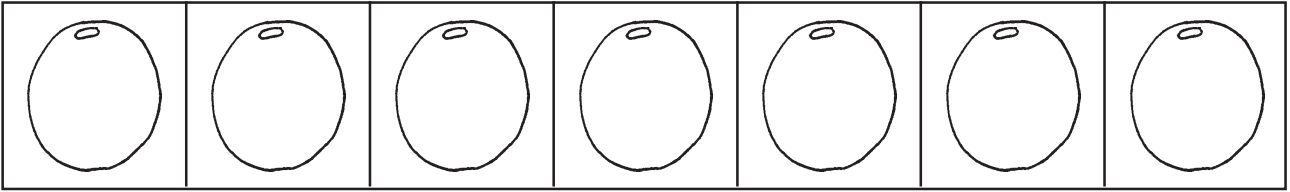
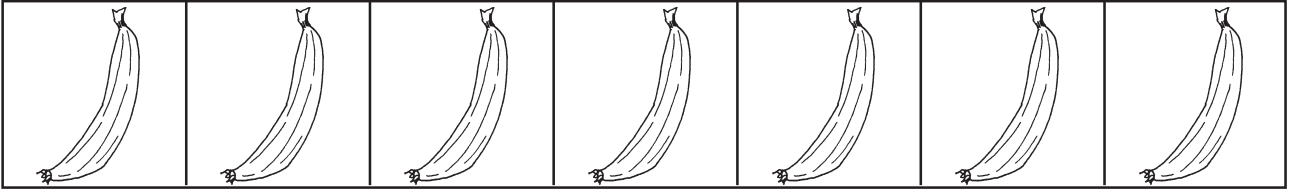
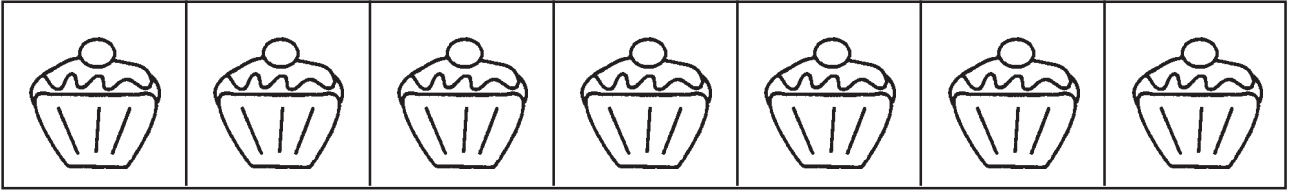
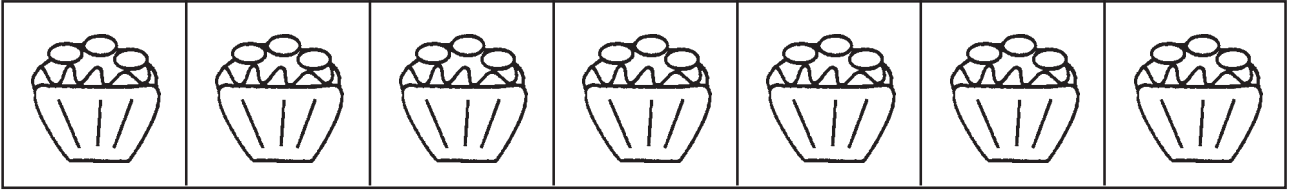
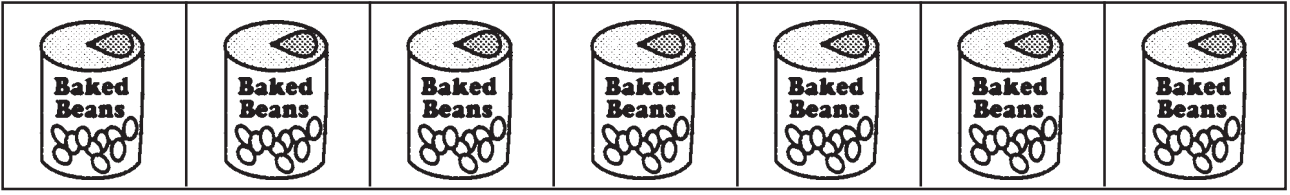
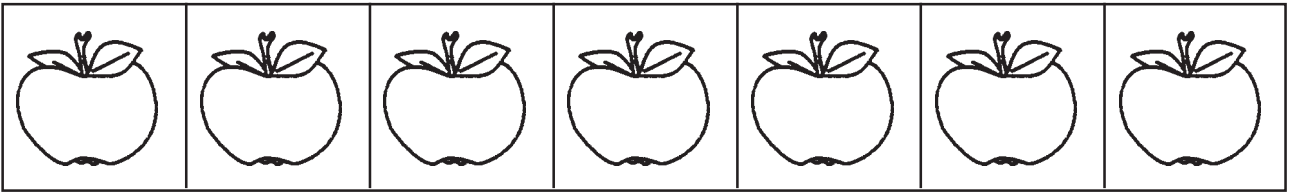

Wolf Stew

Listen & Draw

Focus Areas

- language: description
- spatial concepts
- colour

Preparation

- Make duplicate copies of Wolf Stew

Suggested Use

1. Place a barrier between players. Players on each side of the barrier have:
 - the wolf stew picture
 - a matching set of coloured pencils
2. Players take turns to draw something on the scene and then give directions so that the other player can draw an identical item in the same location. Ideas for additional scene items could include vegetables added to the cooking pot or words written in the speech balloon. *“Draw 3 orange carrots in the middle of the pot.”*
3. The barrier is then removed and the drawings are compared. Players note any differences that occurred.

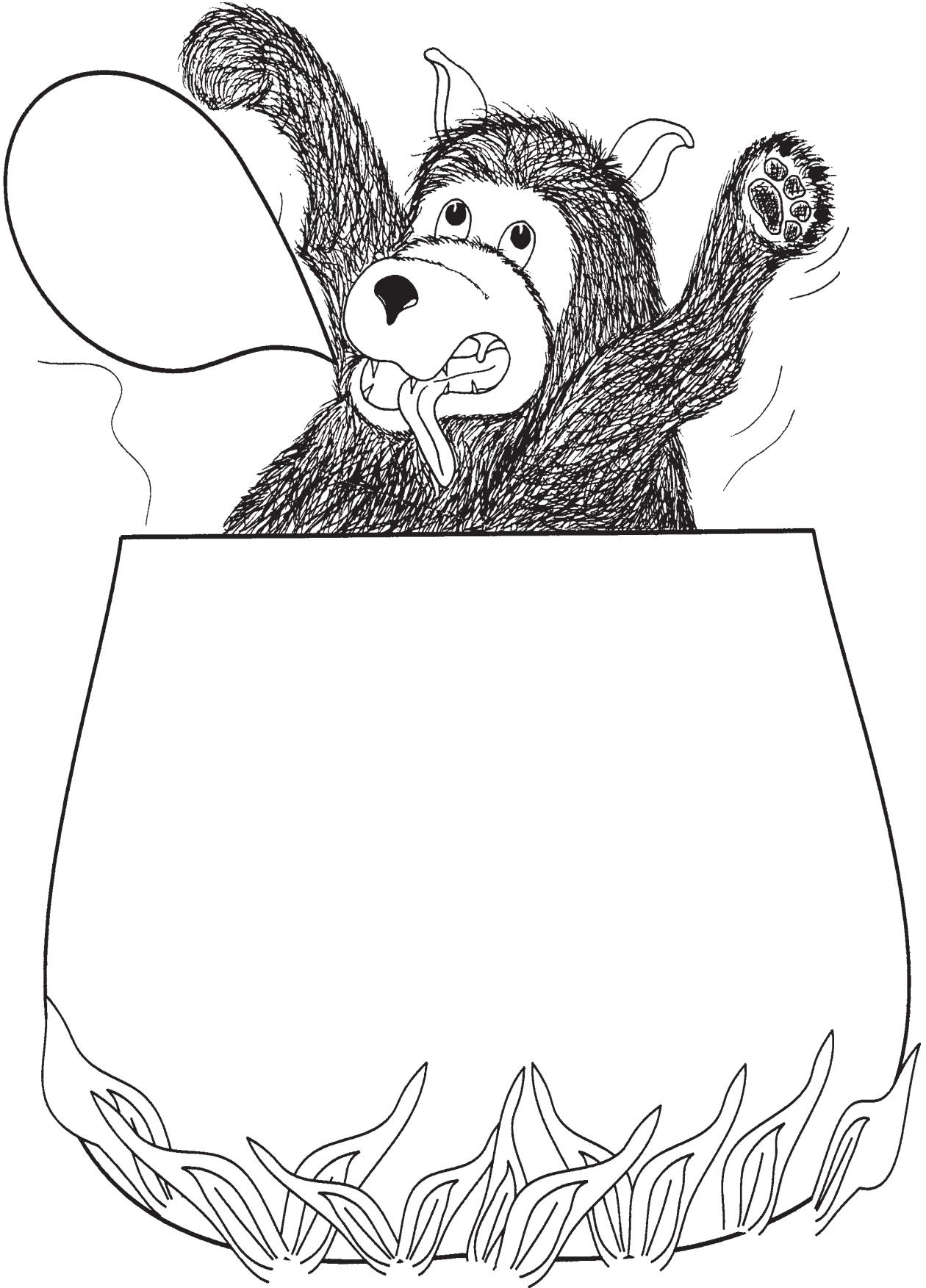

Dress The Bears

Focus Areas

- language: names of clothes
- attributes: colour and pattern

Preparation

- Make duplicate copies of Dress Bear 1 & 2.
Note: Copy onto light card to create a sturdier set of pieces.
- Cut out bear and clothes.
Tip: Mark backs of each clothes and bear set differently for easy sorting.

Suggested Use

1. Place a barrier between players. Players on each side of the barrier have:
 - a bear
 - a set of clothes
2. Players take turns to dress a bear giving instructions to the other player so that they dress the bear in identical clothes.
3. The barrier is removed and the bears are compared. Players note any differences.
4. The barrier is replaced and the game proceeds with the other player dressing the bear and giving instructions.

Variations

- **Colour** Copy the clothes onto coloured paper or light card to create coloured sets of clothes or colour the clothes to create contrasting colours, e.g. red pants with blue spots, yellow and green striped shirt, etc.
- **Size** Use the photocopier to enlarge or reduce the bear and the clothes so that players choose between different sizes. *“Dress Papa bear with the big striped shirt.”*

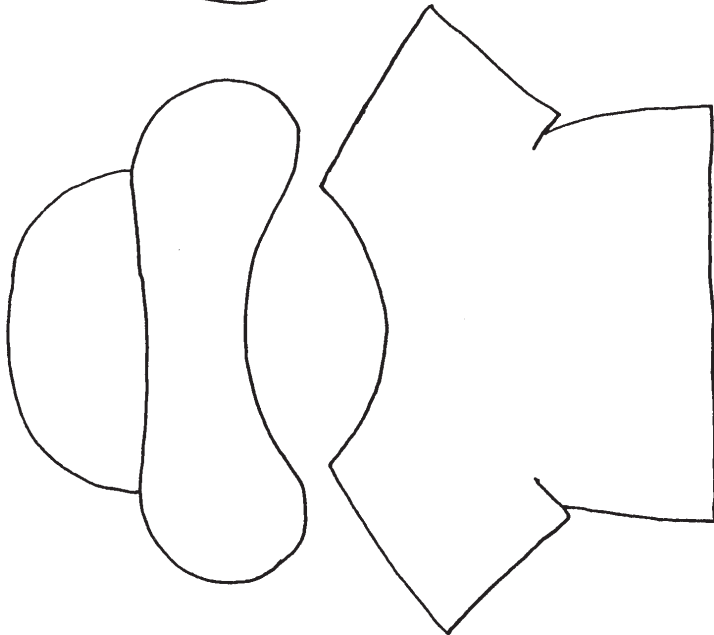
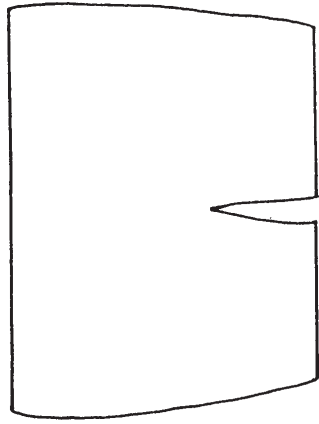
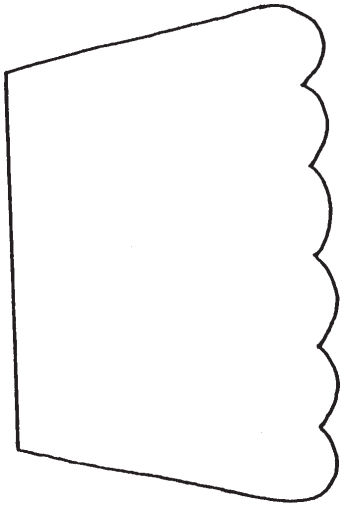
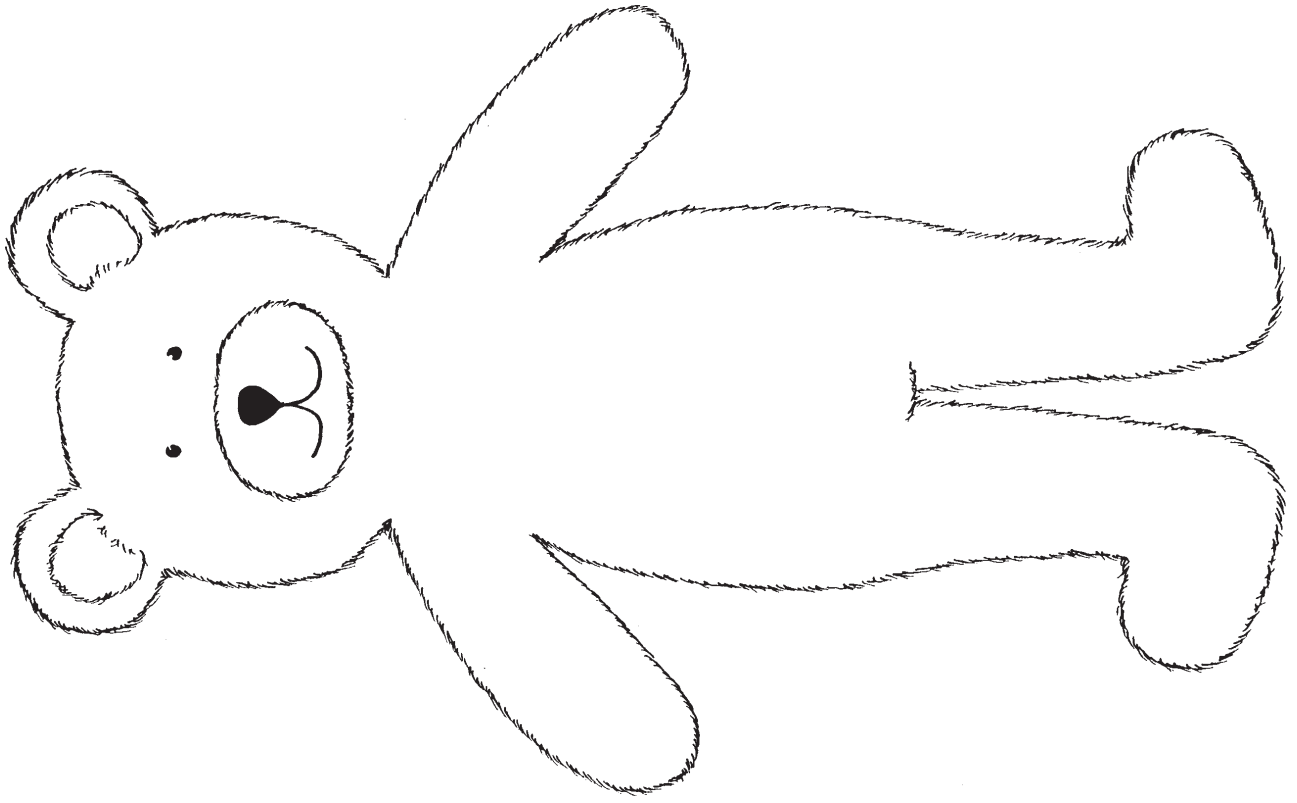

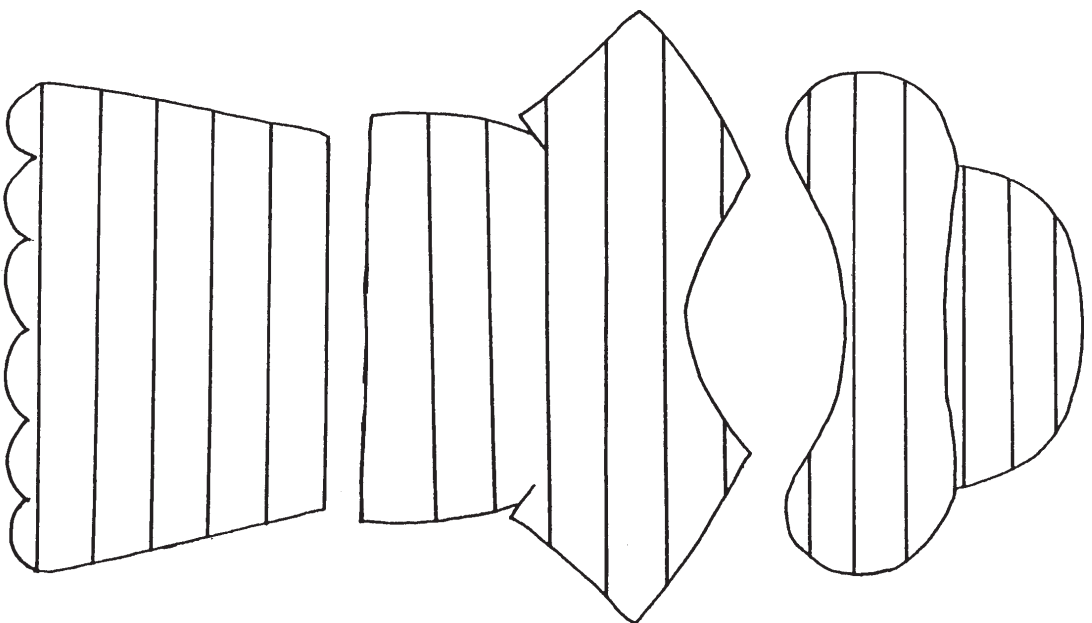
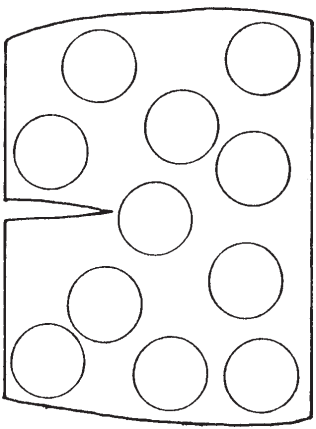
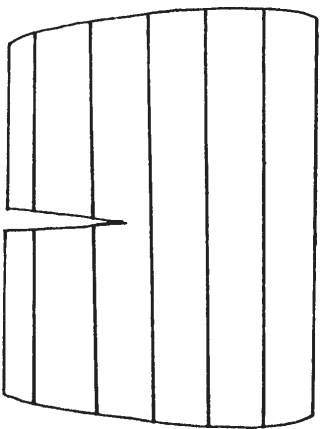
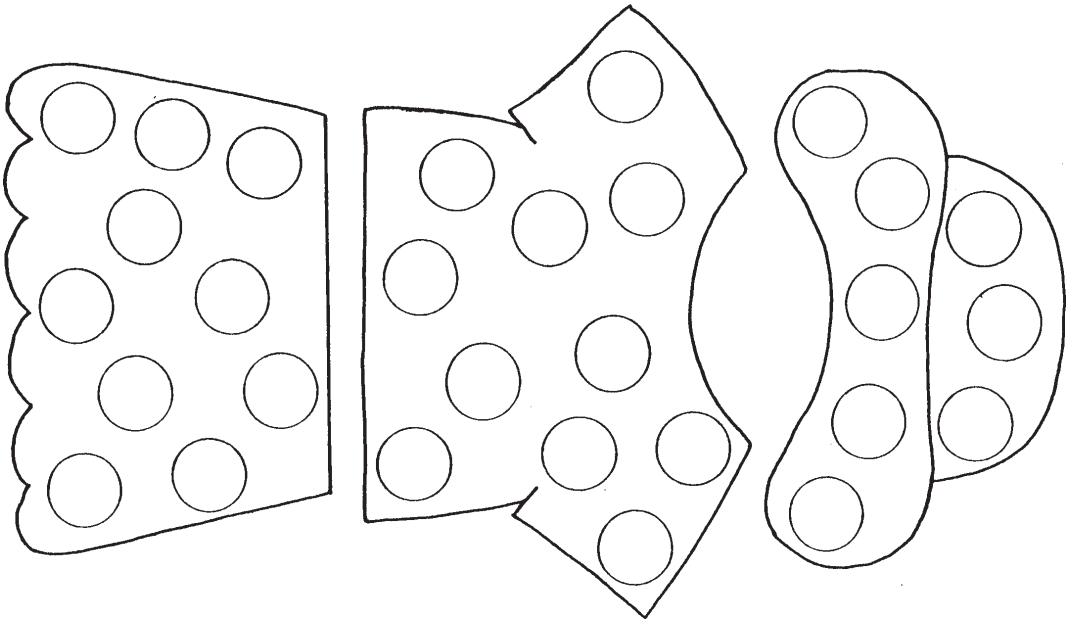

Three Bears

Spot the Difference

Focus Areas

- language: description
- spatial concepts

Preparation

- Copy scenes Three Bears 1 & 2

Suggested Use

1. Place a barrier between players. You need:
 - a copy of scenes Three Bears 1 and Three Bears 2
 - pencils
2. One Player is given Three Bears 1 and the other player is given Three Bears 2.
3. Players take turns to describe or ask questions about the scene to find where the differences are, e.g. *"I can see two bees above the flower near Papa Bear. Can you?"*
4. Players mark any differences they discover with the pencil.
5. Play continues for a set period of time or until the players have found all the differences.
6. The barrier is then removed and the players compare scenes to check if any items were missed.

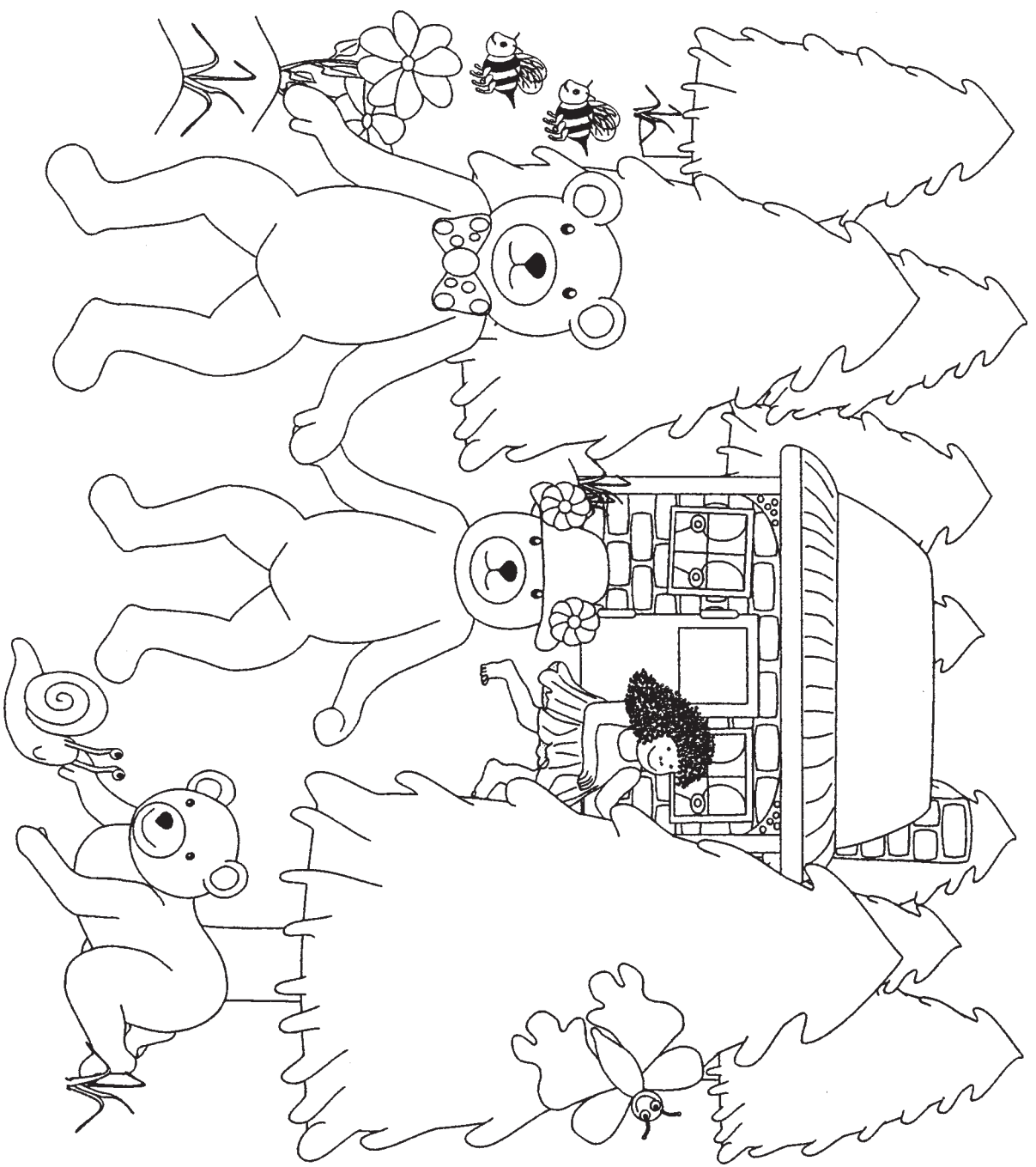

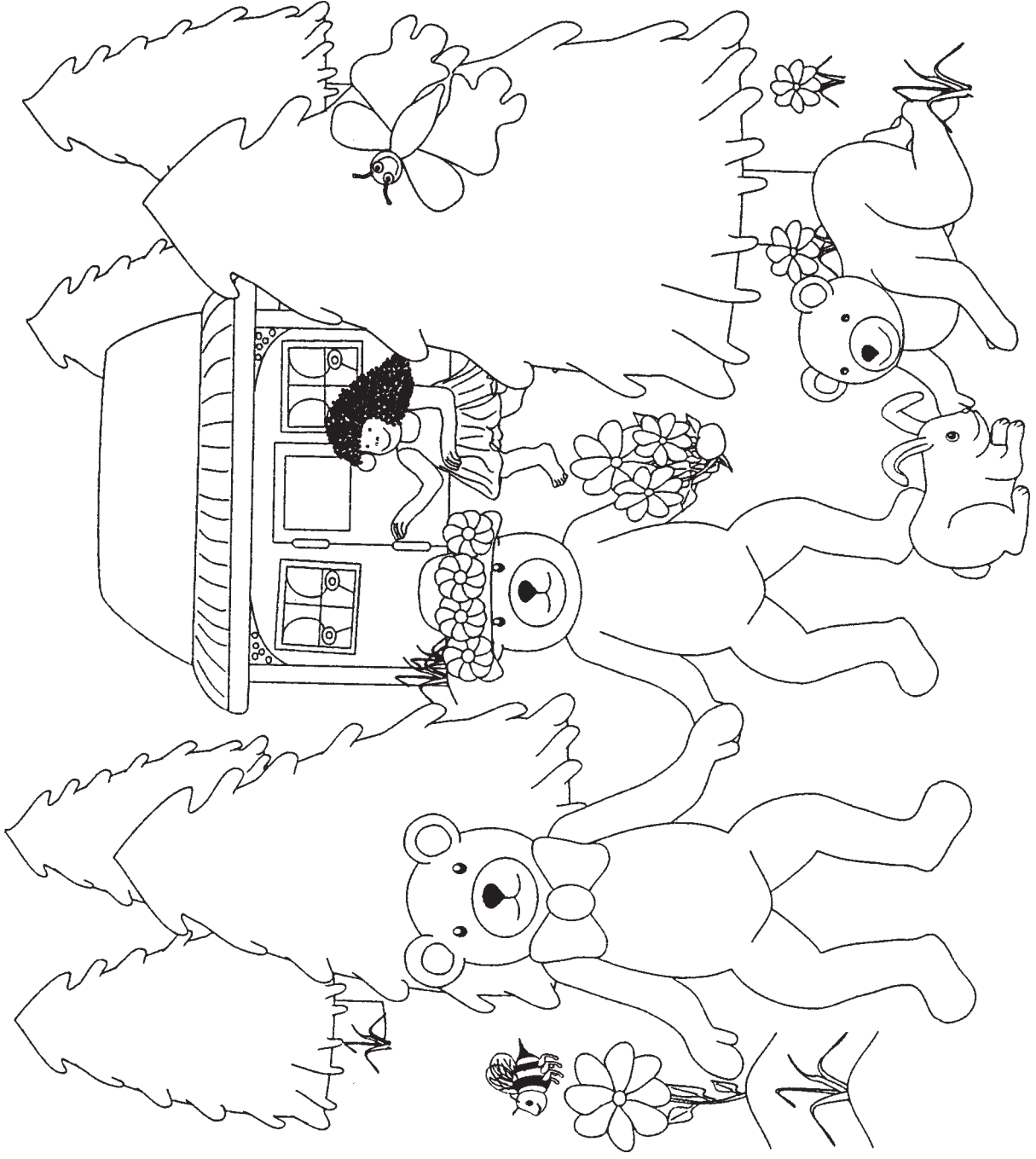

Bear Things

Focus Areas

- language: names of items
- size concepts: little, middle-sized, big, small, medium, large
- initial sounds





Preparation

- Enlarge to A3 and make duplicate copies of 6 or 12 Grid. (See Grids p.125-6)
Write letters for initial sounds to be practised in each grid area. (See example below)
- Make duplicate copies of the Bear Things.
- Cut out Bear Things cards.
Tip: Mark backs of each card set differently for easy sorting.

Suggested Use

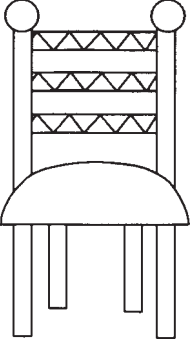
1. Place a barrier between players. Players on each side of the barrier have:
 - a grid
 - a set of bear things cards
2. Players may wish to sort the cards before starting in order to make them easy to locate.
3. Players take turns to select a card and place it on the grid while giving directions to the other player so they can place the same card in the same position, e.g. *“Place Mama Bear’s bed on the /m/ sound.”*
4. Players continue until all the grid areas are filled.
5. The barrier is then removed and the grids are compared. Players note any differences that occurred.

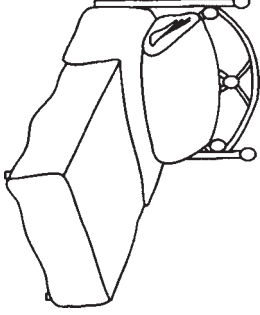
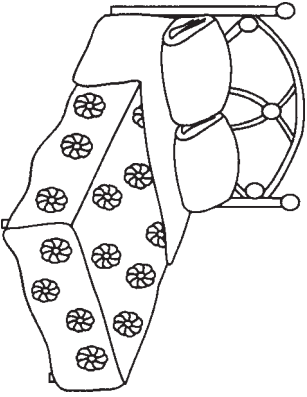
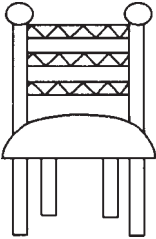
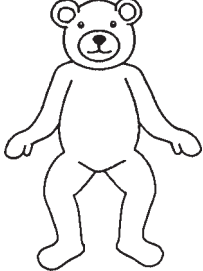
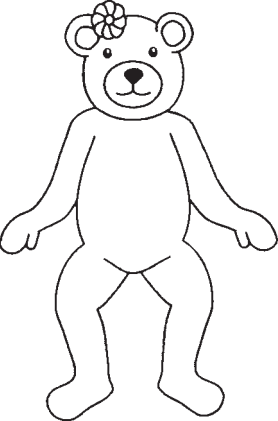
m	b	s	a
c	t	g	w
e	r	p	f

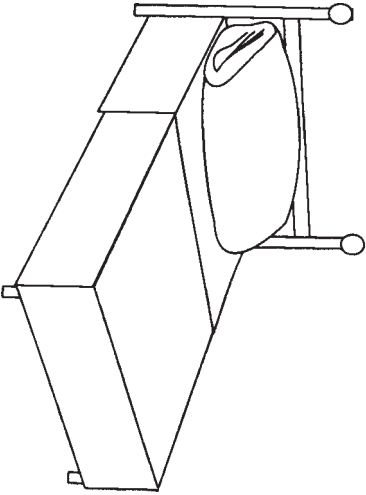
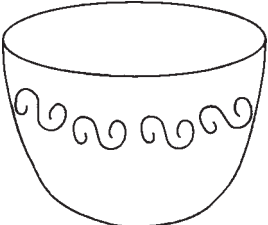
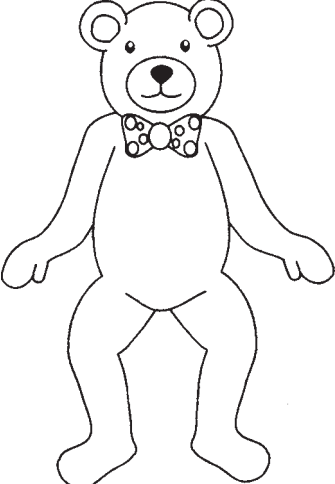
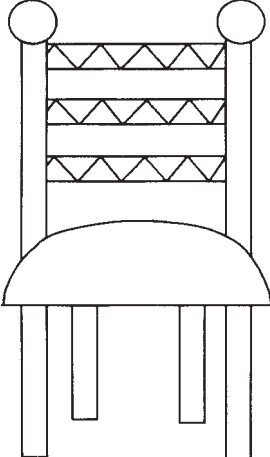
Fairytale Scene

Focus Areas

- language: description
- fairytale characters

Preparation

- Make duplicate copies of the Fairytale Scene.

Suggested Use

1. Before playing, help children identify all the characters on the scene and orally retell the fairytales represented.
2. Place a barrier between players. Players on each side of the barrier have:
 - a fairytale scene
 - a matching set of coloured counters
3. Players take turns to give directions for placing a coloured counter on the fairytale scene, e.g. *“Put a yellow counter on the wolf’s tail.”*
4. Players continue until all the counters are placed.
5. The barrier is then removed and the scenes are compared. Players note any differences that occurred.

Variations

- **Draw on the Scene** Use a matching set of coloured pencils. Players give directions for adding items to the scene or colouring parts of the scene, e.g. *“Draw a bird above the little pig’s head.”*

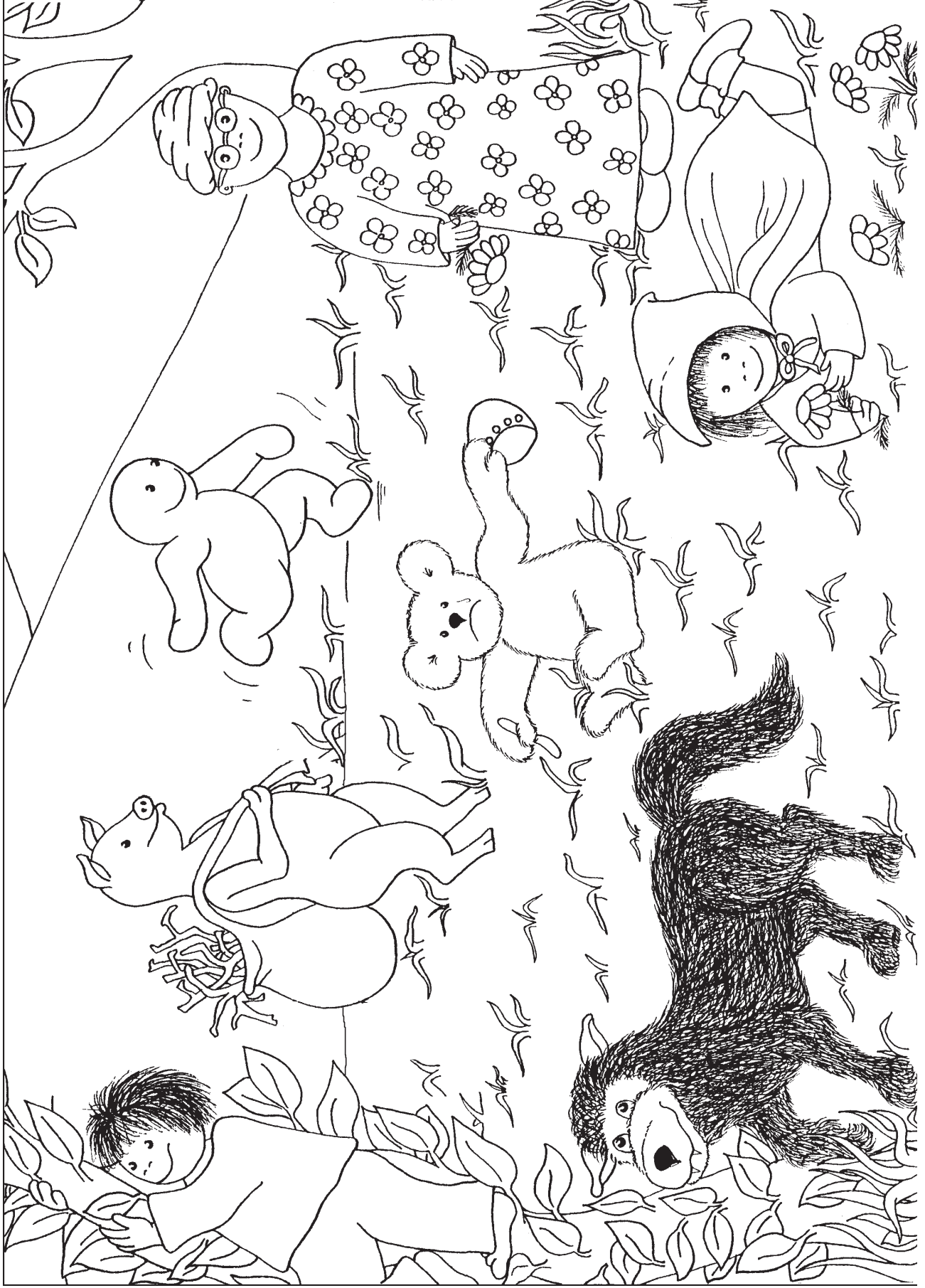

Nursery Rhyme Scene

Focus Areas

- language: description
- nursery rhyme characters

Preparation

- Make duplicate copies of the Nursery Rhyme Scene.

Suggested Use

1. Before playing, help children identify all the characters on the scene and recite the matching nursery rhymes.
2. Place a barrier between players. Players on each side of the barrier have:
 - a nursery rhyme scene
 - a matching set of coloured attribute blocks
3. Players take turns to give directions for placing a block on the nursery rhyme scene, e.g. *“Put a small red square on the spider.”*
4. Players continue until all the blocks are placed.
5. The barrier is then removed and the scenes are compared. Players note any differences that occurred.

Variations

- **Draw on the Scene** Use a matching set of coloured pencils. Players give directions for adding items to the scene or colouring parts of the scene, e.g. *“Draw a spider’s web in the tree above the spider.”*

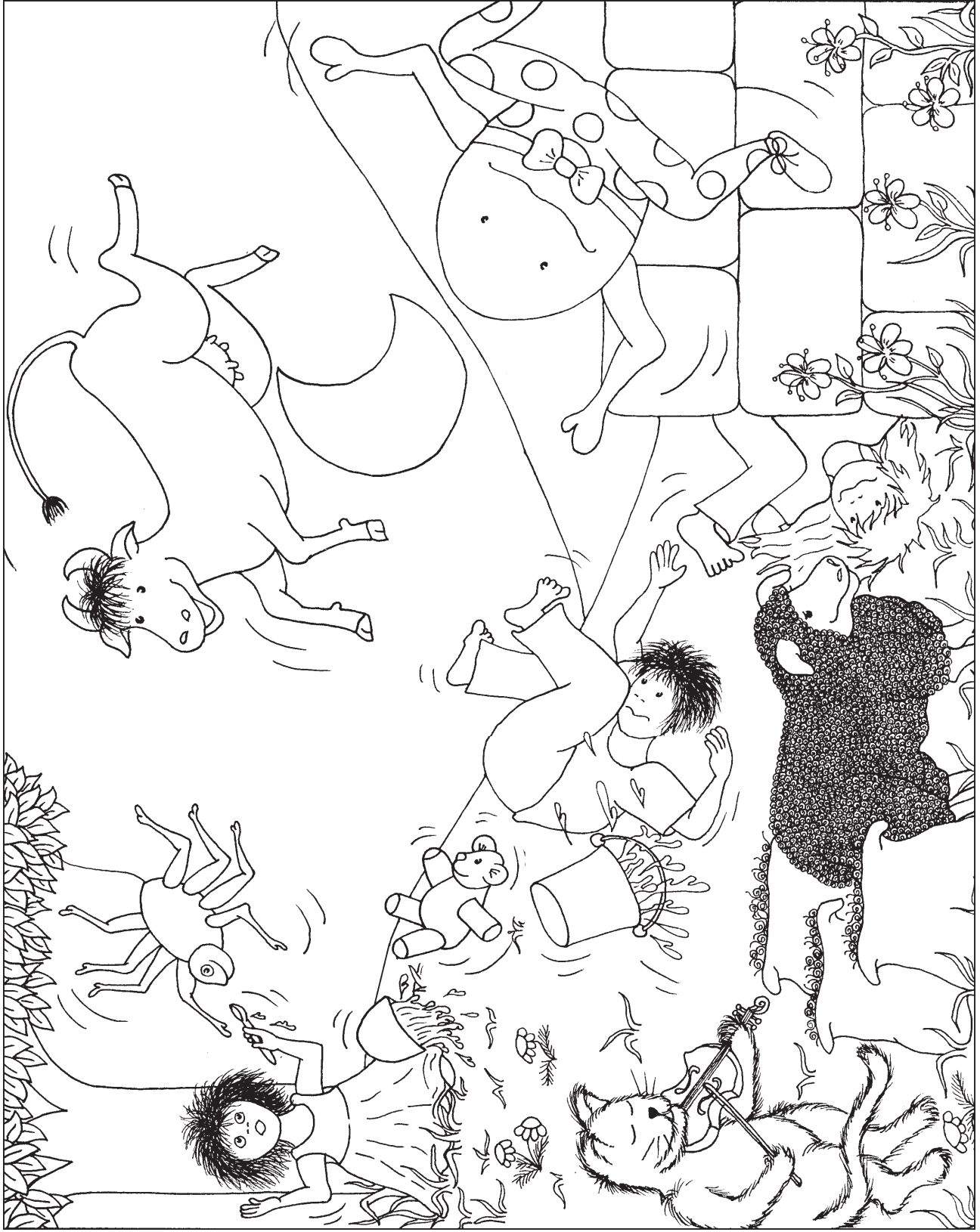

Dragon Map

Focus Areas

- map coordinates
- number: addition

Preparation

- Make duplicate copies of the Dragon Map.
You may wish to enlarge it on the photocopier.

Suggested Use

1. Place a barrier between players. Players on each side of the barrier have:
 - a dragon map
 - a pencil
2. Players begin by plotting the letters onto the map area:
 - T for treasure chest (x1)
 - C for crowns (x3)
 - N for necklaces (x3)
 - G for gold (x4)
 - D for dragons (x4)
3. Players take turns to call out a coordinate, e.g. *“Is there anything on J6?”* The other player responds by saying *“miss”* if nothing was in that area or naming the item if a letter was marked in the area, e.g. *“You have a treasure chest.”*
If a treasure item is uncovered, players mark the points in the score box.
4. If a player calls a coordinate for an area which has D for dragon marked, one life chance is lost.
5. The game is over when either one player finds all the treasure items or one player loses all their life chances.
6. Players then tally their total score for treasure found to see who has the most points.

A B C D E F G H I J K L M N O

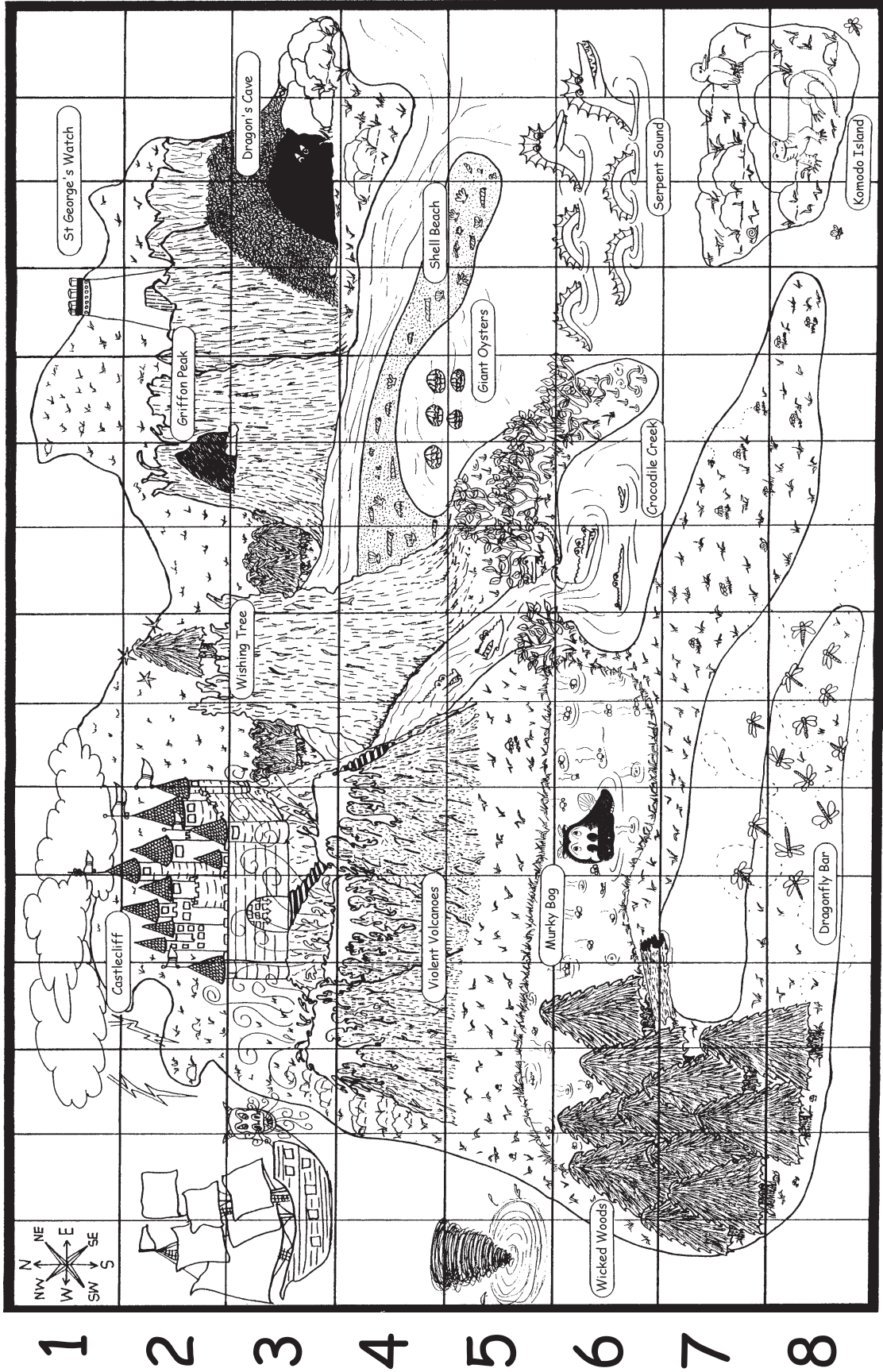

Mark these letters on the map.

T		100 points
C		50 points
N		20 points
G		10 points
D		10 points

You have three life chances.
You lose a chance each time
you meet a dragon.

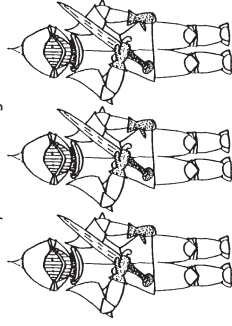

Game	Score	Total
1		
2		
3		

Bunyip Mix & Match

Focus Areas

- language: description
- body parts
- visual discrimination

Preparation

- Make duplicate copies of the Mix & Match Bunyips 1, 2 & 3.

Suggested Use

1. Before playing, ask children to identify the different attributes shown on the head, body and leg sections. Model for children how to describe and identify the different features by playing a “Find me” game, e.g. *“I have small ears and a big nose with spots on it. Who can find me?”*
2. Place a barrier between players. Players on each side of the barrier have:
 - a set of bunyip heads, bodies and legs.
3. One player chooses a head, body and leg part to assemble a bunyip, describing the cards to the other player so that they can assemble the same bunyip.
4. The other player now does the same and describes the head, body and leg parts to the first player.
5. The barrier is removed and the bunyips are compared. Players note any differences.
6. Play continues for a set period of time or until each player has had several turns at giving and receiving directions.

Note: The bunyip is a mythical Australian bush creature of Aboriginal legend. It is known to live in and around waterholes and billabongs and is usually depicted as a creature of fun and mischief.

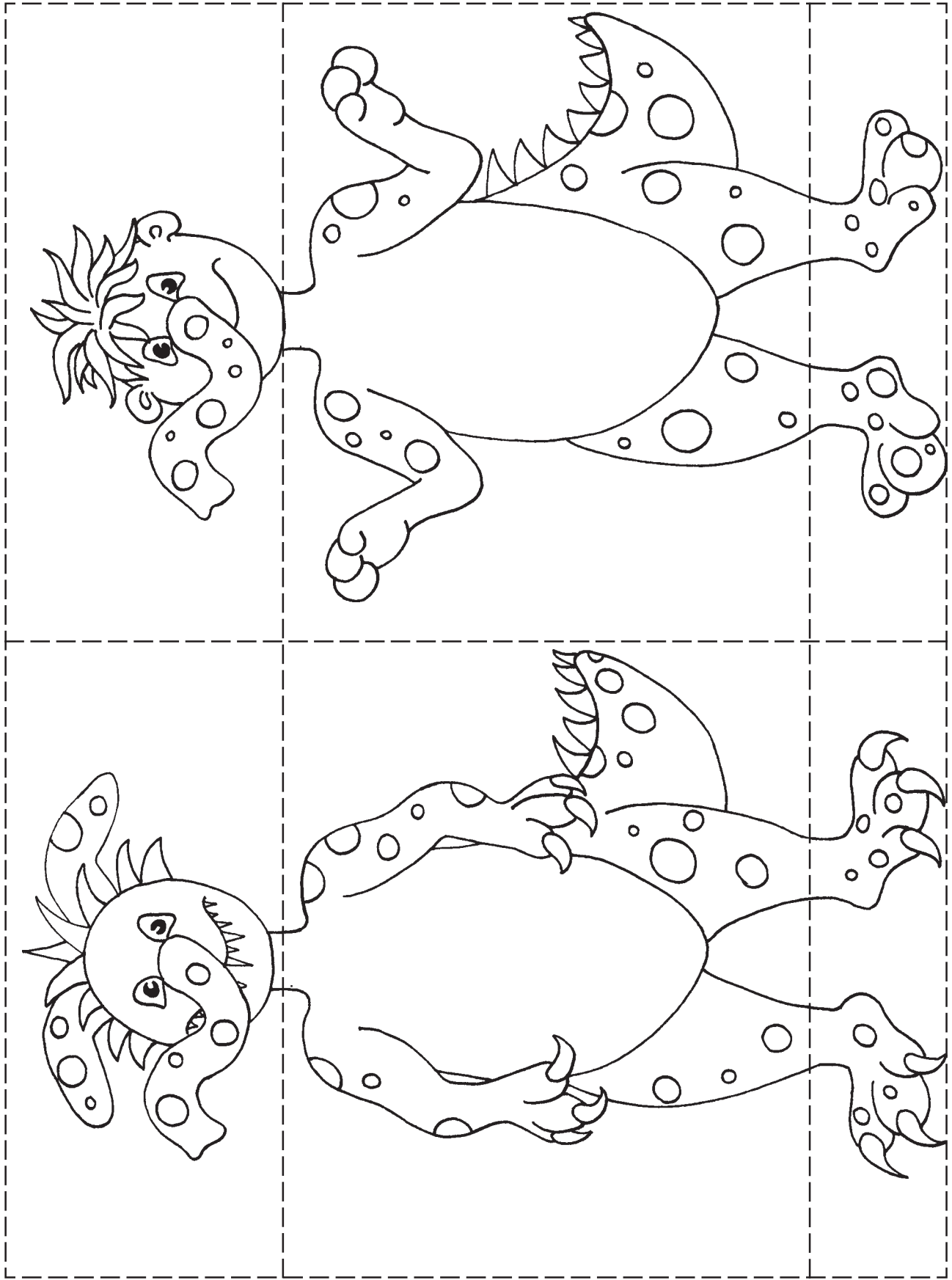

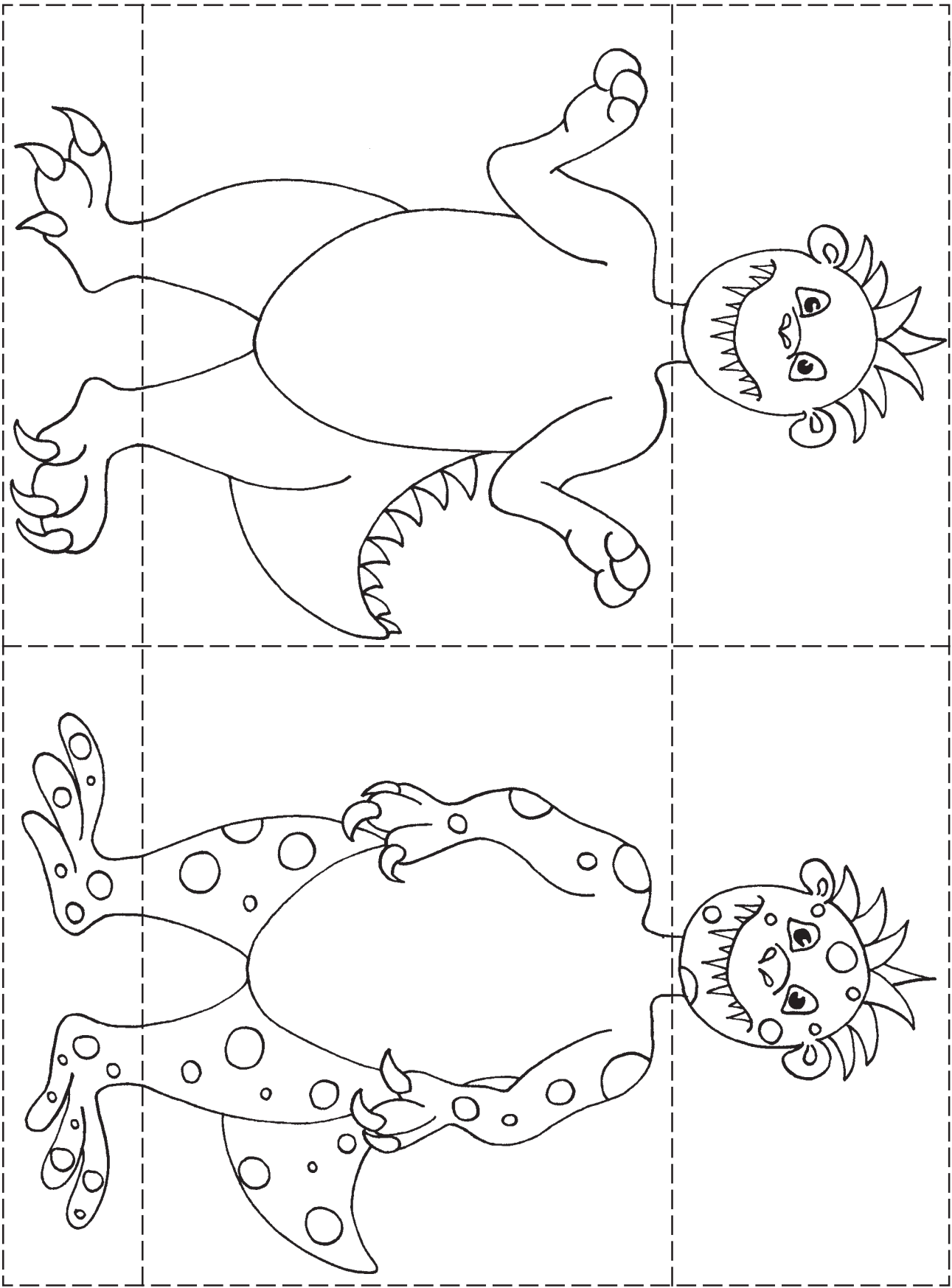

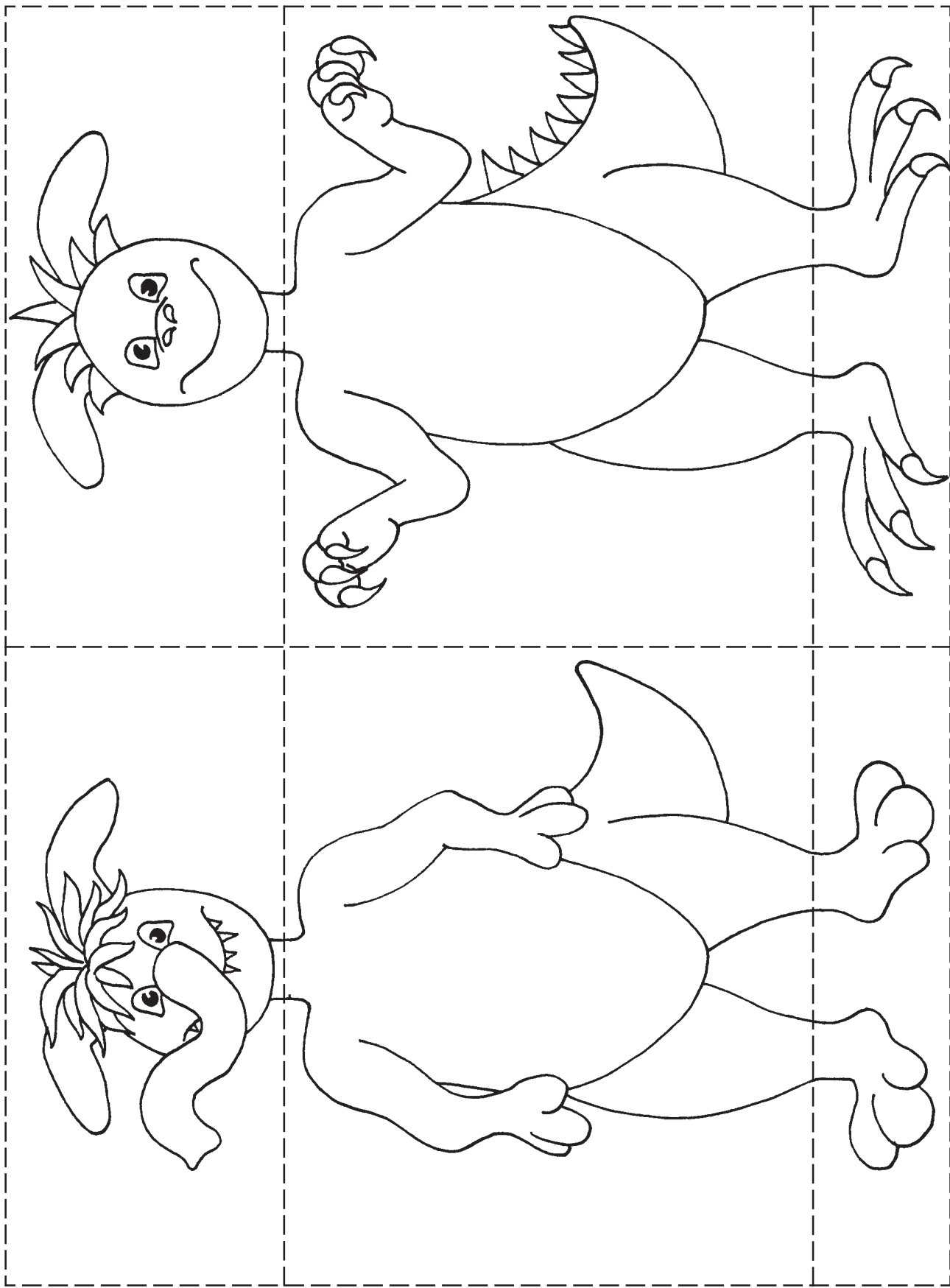

Bunyip Brothers

Focus Areas

- language: description
- body parts
- visual discrimination

Preparation

- Enlarge and make duplicate copies of a 6 Grid. (See Grids p.125-6)
Write letters for diagraph sounds to be practised in each box (See example below).
- Make duplicate copies of the Bunyip Brothers cards.
- Cut out the cards.

Suggested Use

1. Place a barrier between players. Players on each side of the barrier have:
 - a 6 grid
 - a set of bunyip cards
2. Players take turns to select a card and place it on the grid, then describe the bunyip and the sound of the diagraph to the other player so they can place the same card in the same position, e.g. *“Place the bunyip with small ears, a bent nose, a short tail and spots on the /ea/ sound.”*
3. Players continue until all the grid areas are filled.
4. The barrier is then removed and the grids are compared. Players note any differences that occurred.

Note: The bunyip is a mythical Australian bush creature of Aboriginal legend. It is known to live in and around waterholes and billabongs and is usually depicted as a creature of mischief.

ea	ch	er
ar	sh	oa

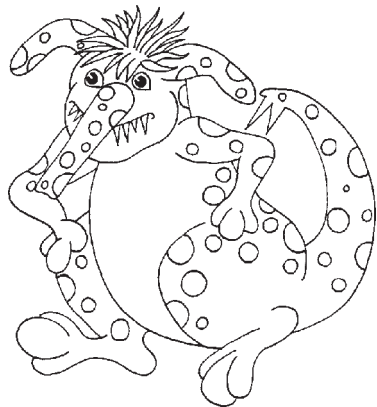

Bunyip's Lagoon

Spot the Difference

Focus Areas

- language: description
- spatial concepts

Preparation

- Copy Bunyip's Lagoon 1 & 2

Suggested Use

1. Place a barrier between players. You need:
 - a copy of scenes Bunyip's Lagoon 1 and Bunyip's Lagoon 2
 - pencils
2. One Player is given Bunyip's Lagoon 1 and the other player is given Bunyip's Lagoon 2.
3. Players take turns to describe or ask questions about the scene to find where the differences are, e.g. *"I can see two bees above the flower near Papa Bear. Can you?"*
4. Players mark any differences they discover with the pencil.
5. Play continues for a set period of time or until the players have found all the differences.
6. The barrier is then removed and the players compare scenes to check if any items were missed.

Note: The bunyip is a mythical Australian bush creature of Aboriginal legend. It is known to live in and around waterholes and billabongs and is usually depicted as a creature of mischief.

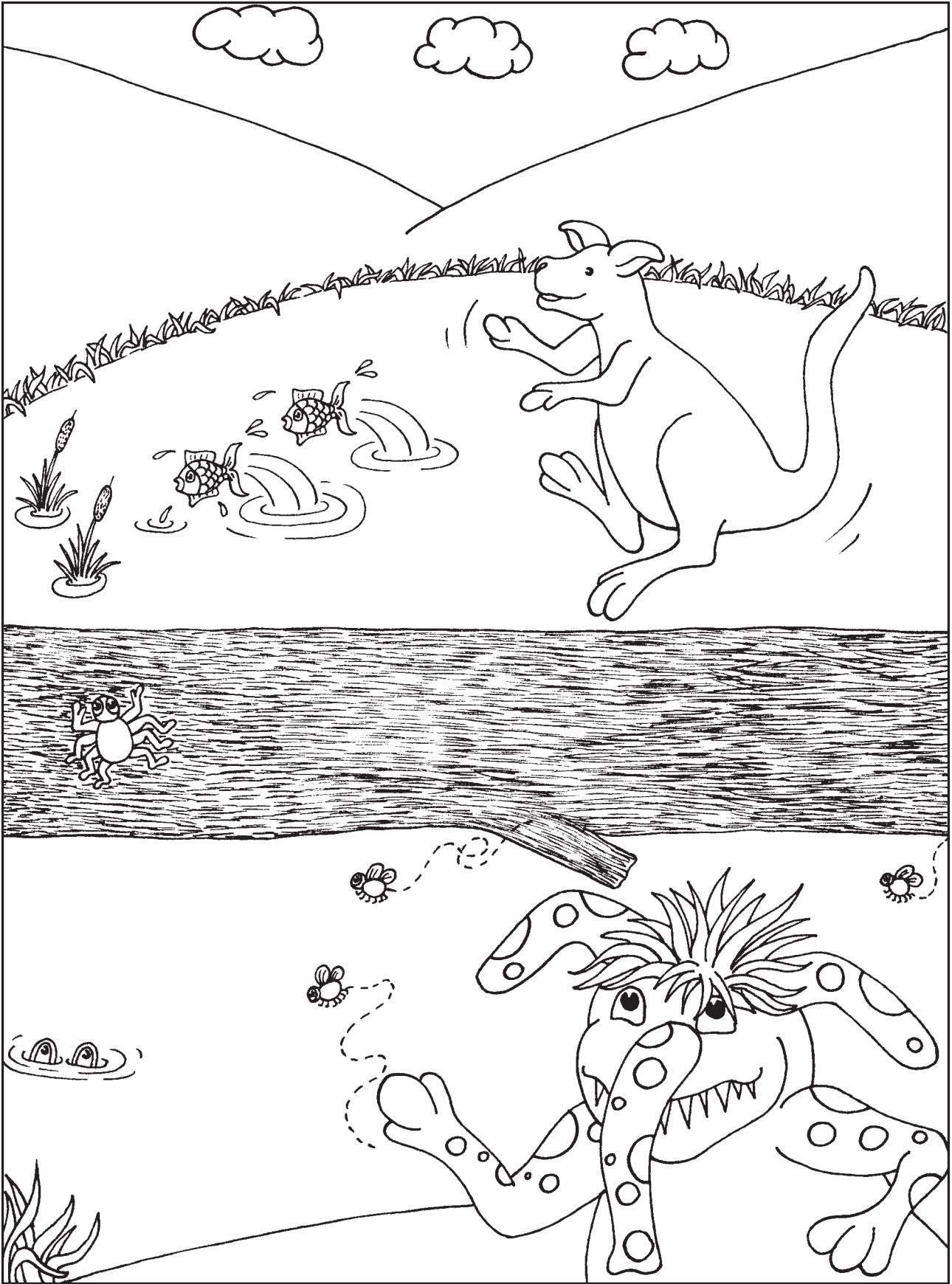

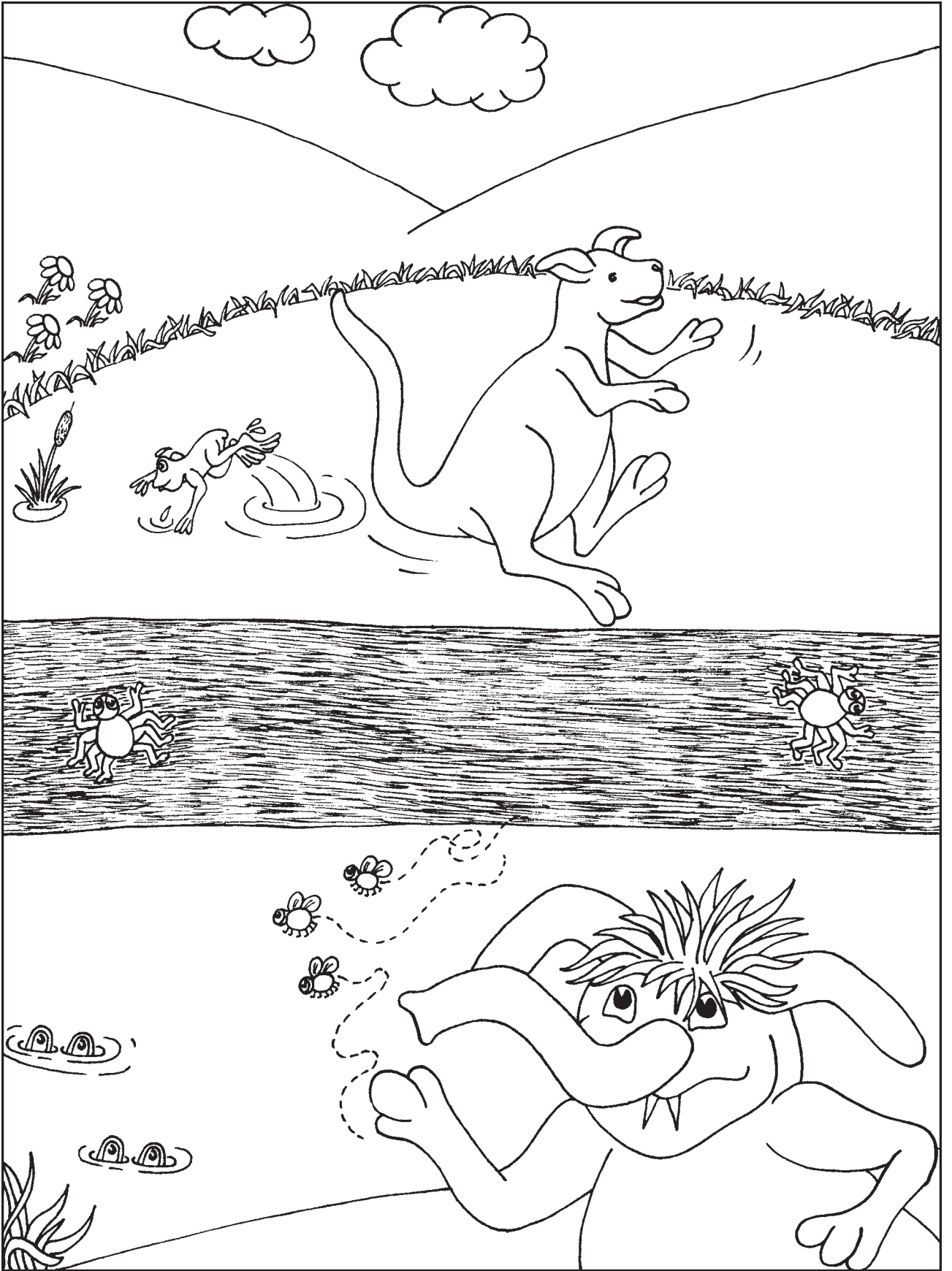

At the Lagoon

Focus Areas

- language: names of animals, land features
- spatial concepts
- directional concepts: facing left, facing right
- attributes

Preparation

- Make duplicate copies of Lagoon Animals.
- Make duplicate copies of the Lagoon Scene.
- Cut out Lagoon Animals.

Tip: Mark backs of each animal set differently for easy sorting.

Suggested Use

1. Place a barrier between players. Players on each side of the barrier have:
 - a lagoon scene
 - a set of animals
2. Players take turns to add an animal to the scene, giving directions to the other player so that they place the same animal in the same position, e.g. *“Choose the spotted frog that’s sitting down and put it on the lily pad.”*
3. Play continues until each player has had several turns at giving and receiving directions. (There is no need to place all the pieces on the scene!)
4. The barrier is then removed and the scenes are compared. Players note any differences that occurred.

Variations

- **Colour** Extend the activity by colouring the animals with different colours and encouraging more precise description, e.g. *“Choose the red fish with spots.”*

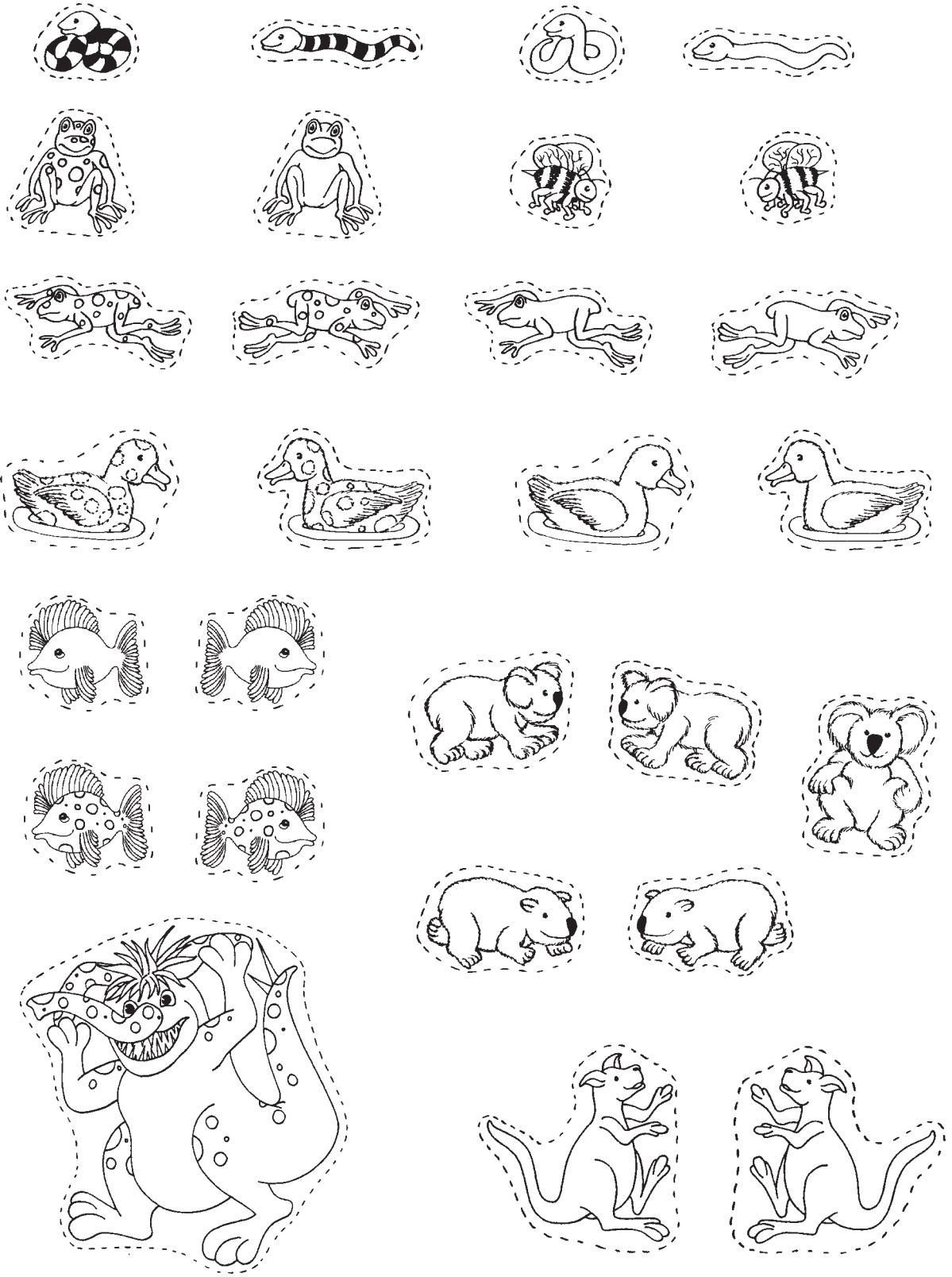

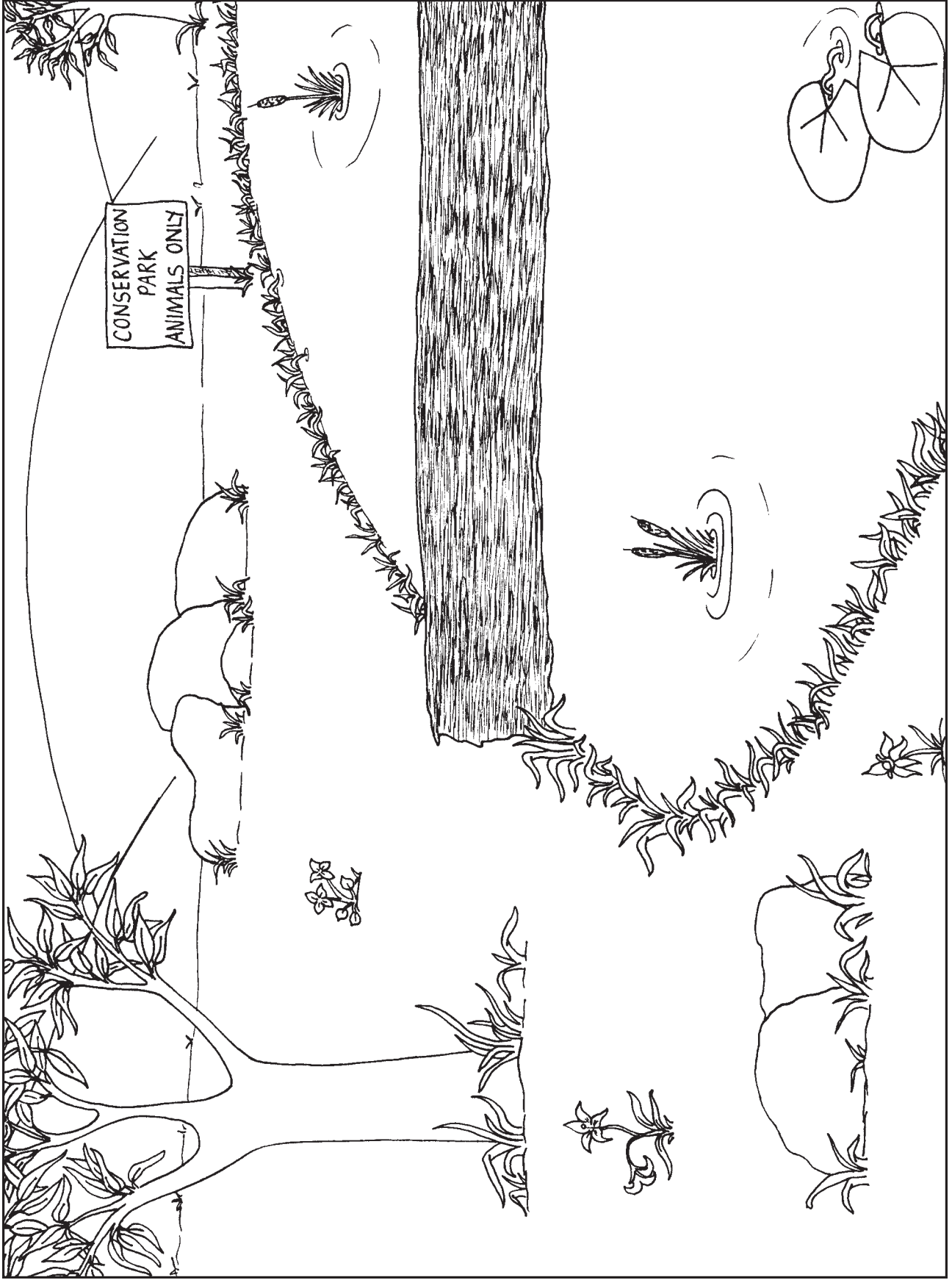

Bunyip's Belly

Focus Areas

- language: names of animals
- number: counting

Preparation

- Make duplicate copies of Bunyip's Belly.
- Make a copy of Bunyip's Food.
- Cut out food cards.

Tip: Mark backs of each food card set differently for easy sorting.

Suggested Use

1. Place a barrier between players. Players on each side of the barrier have:
 - a bunyip's belly
 - a set of bunyip's food cards
2. One player places a selection of food items into bunyip's belly while giving directions to the other player to do the same, e.g. *"Place the 5 bees and 3 fish and 2 snails into bunyip's belly."*
3. The barrier is then removed and the bunyips are compared. Players note any differences that occurred.
4. The other player then has a turn to place food items into bunyip's belly and give directions.
5. Play continues until players have had several turns at giving and receiving directions.

Variations

Belly Limit Set a total number for bunyip's belly, e.g. 10 items. Players then place a combination of food items in bunyip's belly to equal the total limit.

Note: The bunyip is a mythical Australian bush creature of Aboriginal legend. It is known to live in and around waterholes and billabongs and is usually depicted as a creature of mischief.

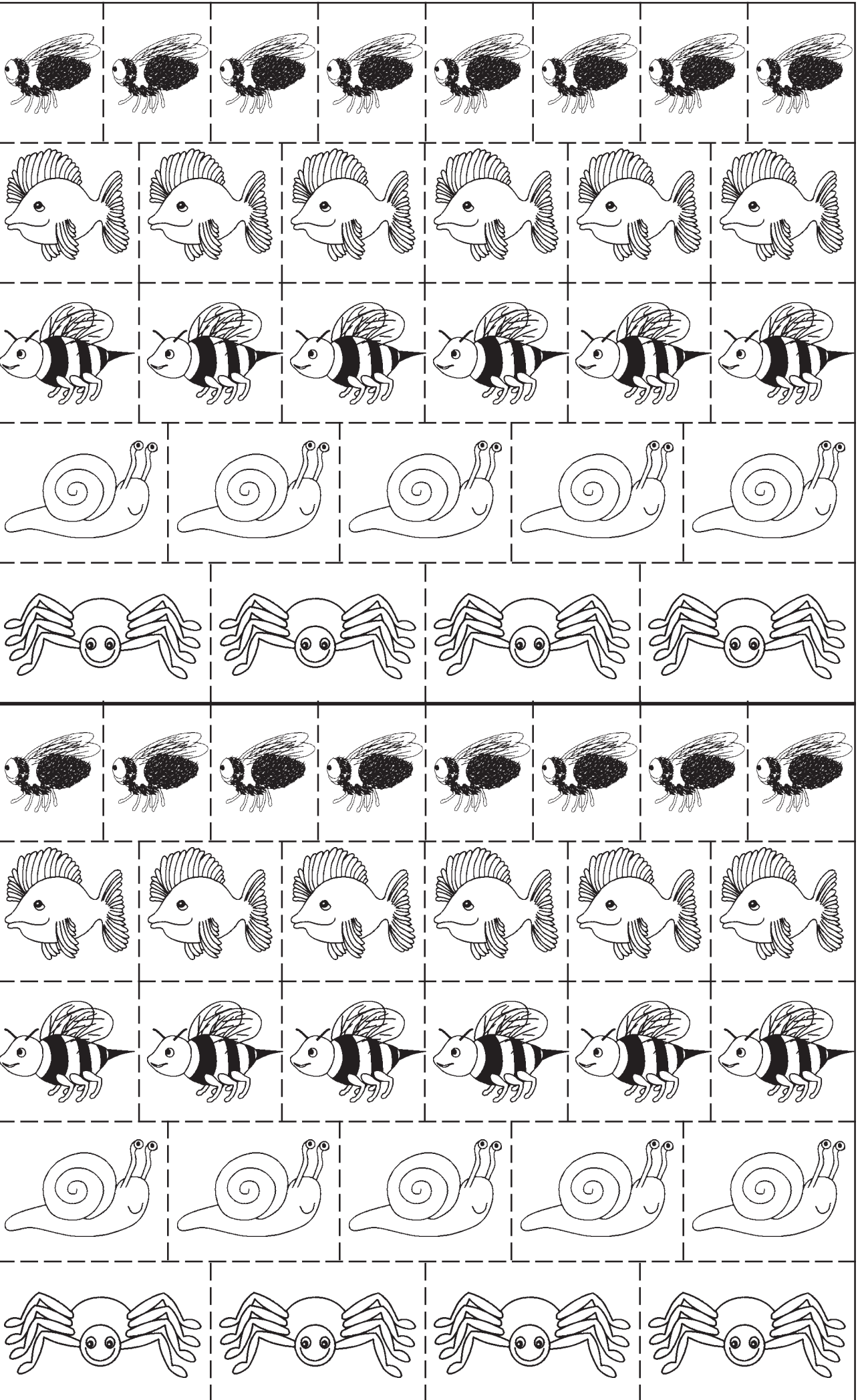

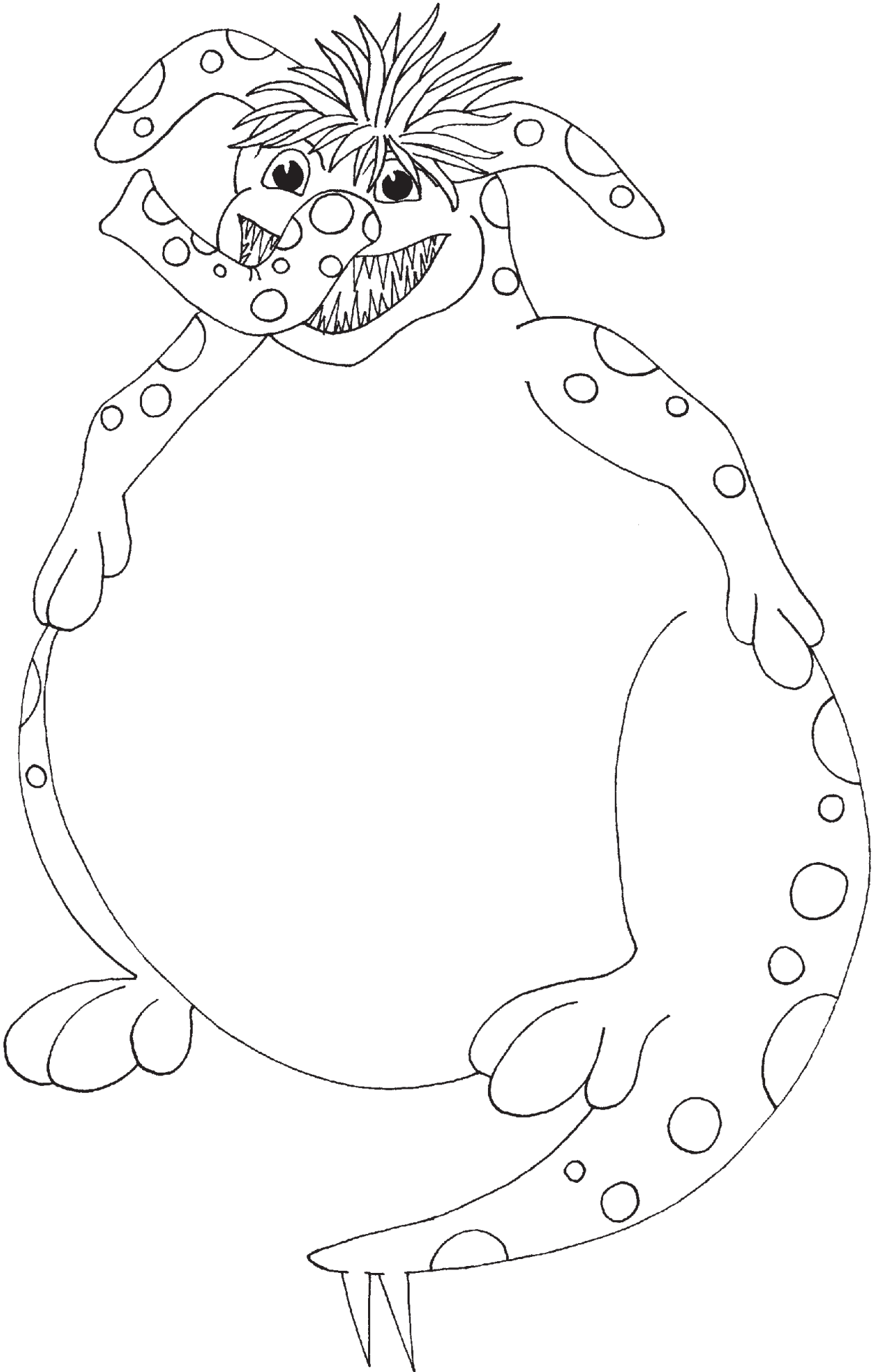

Log Bridge

Focus Areas

- language: names of animals
- ordinal number: 1st to 10th
- spatial concepts: behind, front, after, etc.

Preparation

- Make duplicate copies of the Log Bridge & Animals.
- Cut out the log bridge and the animals.
Tip: Mark backs of each animal set differently for easy sorting.

Suggested Use

1. Before playing, review ordinal numbers and the names of the animals with children. Try acting out the ordering of the animals crossing the log bridge by giving an animal picture to each of 10 children. The remaining class members take turns to call out who is first, second, third, etc and help position the “animals” in order.
2. To play, place a barrier between players. Players on each side of the barrier have:
 - a log
 - a set of animals
3. One player places the animals along the log and uses ordinal numbers to describe their order to the other player, e.g. *“First is the frog, second is the wombat, the snake is third...”*
4. The barrier is then removed and the logs are compared. Players note any differences that occurred.
5. The game continues with the other player taking a turn to place animals along the log and give directions.

Note: The bunyip is a mythical Australian bush creature of Aboriginal legend. It is known to live in and around waterholes and billabongs and is usually depicted as a creature of mischief.

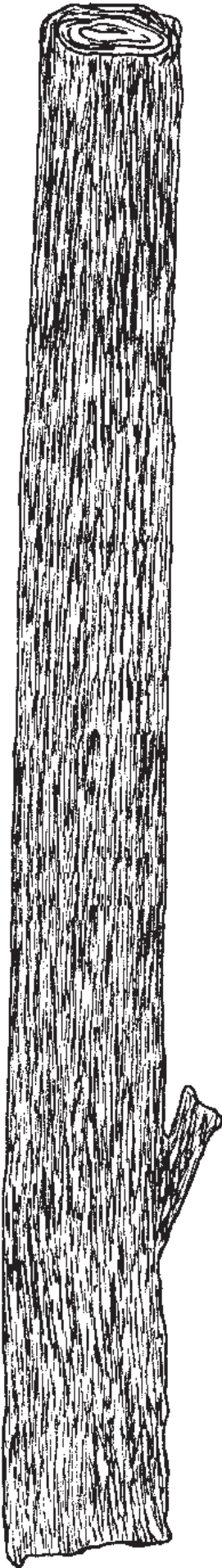

bee



wombat



snake



rat kangaroo

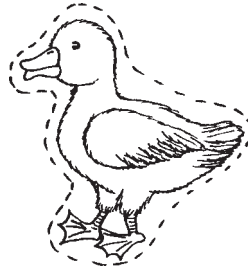

duck



frog



numbat

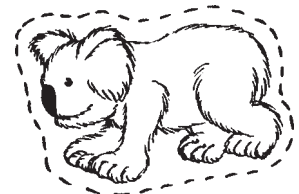

koala



bunyip



kangaroo

Nuts & Bolts

Focus Areas

- language: description
- number: counting

Preparation

- Enlarge to A3 and make duplicate copies of Nuts & Bolts Robots.
- Make a copy of Nuts & Bolts.
- Cut out the pieces and sort into two sets of materials.

Tip: Mark backs of each set of pieces differently for easy sorting.

Suggested Use

1. Place a barrier between players. Players on each side of the barrier has:
 - Nuts & Bolts Robots
 - a set of nuts and bolts
2. One player selects some items, places them on one of the robots and gives directions to the other player who then places the same items on the same robot, e.g. *“Choose 4 bolts and put them on the robot with the triangle head.”*
3. The other player then has a turn to place items on a robot and give directions.
4. The game continues until all robots have items. The barrier is then removed and the robots are compared. Players note any differences that occurred.

Variations

- **Equal Combinations** Make a rule that each robot must equal a set number, e.g. 15. Players must use a combination of items to create the set number.

Enlarge to A3 size when copying

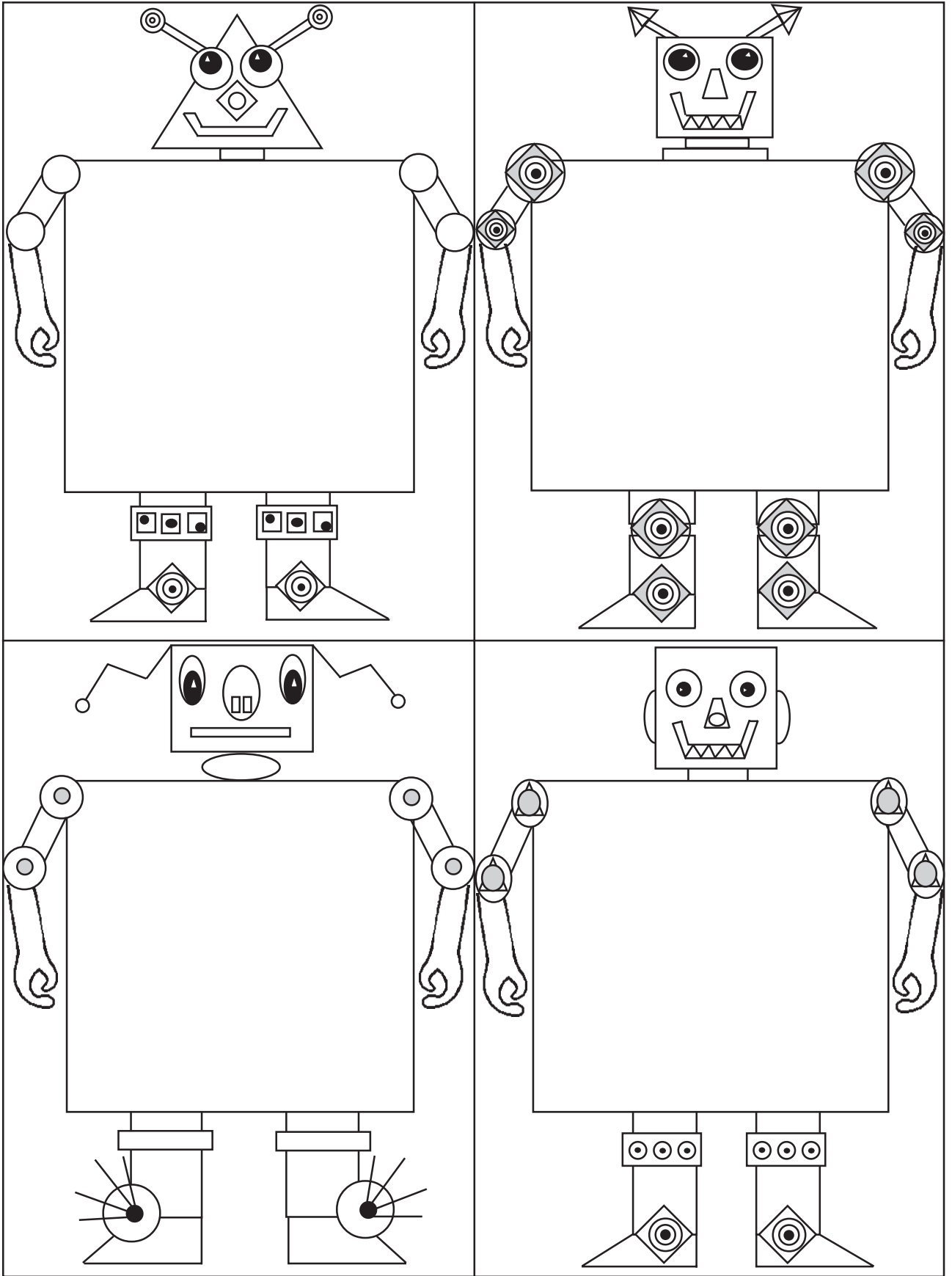

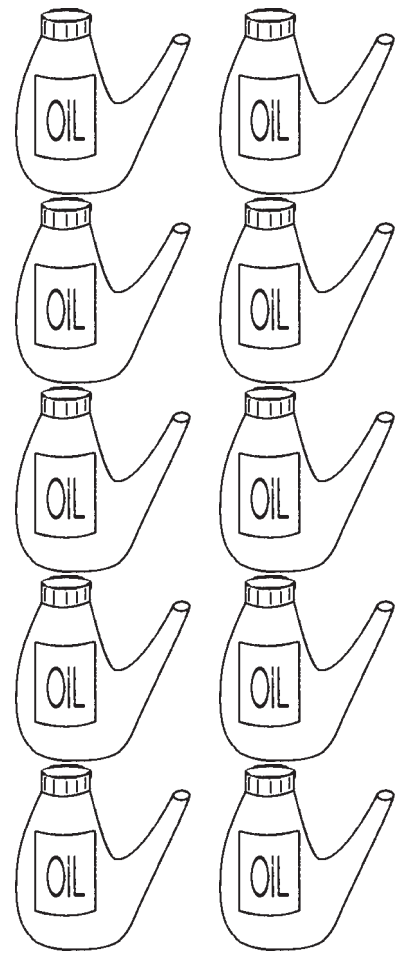
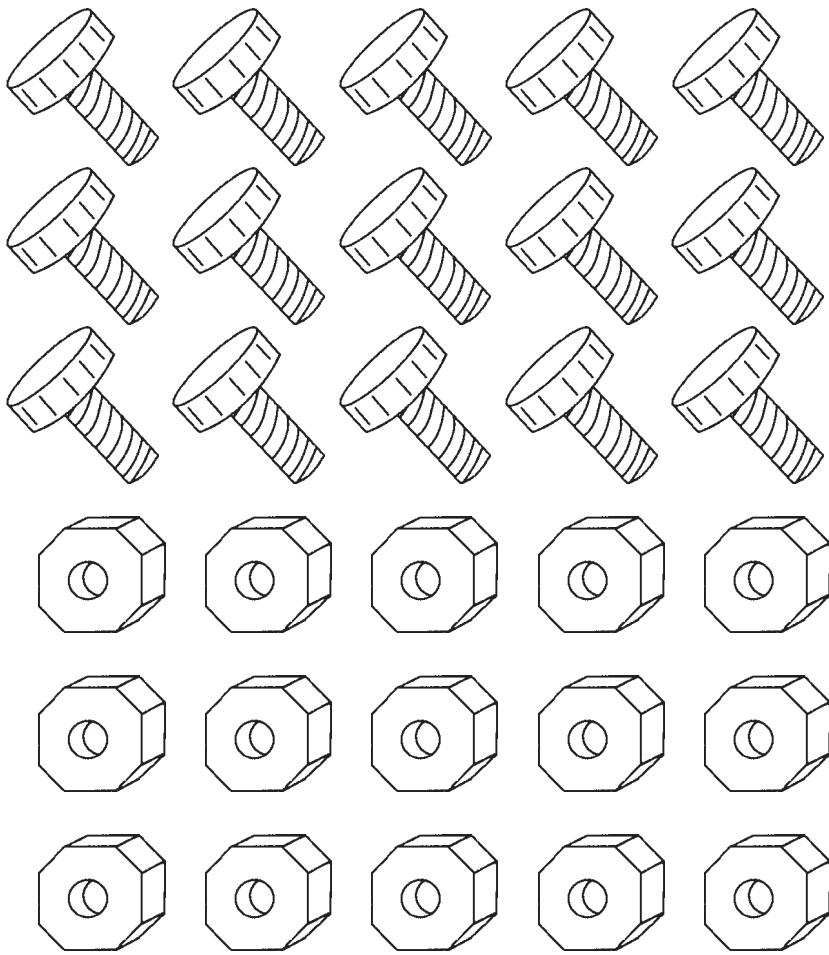
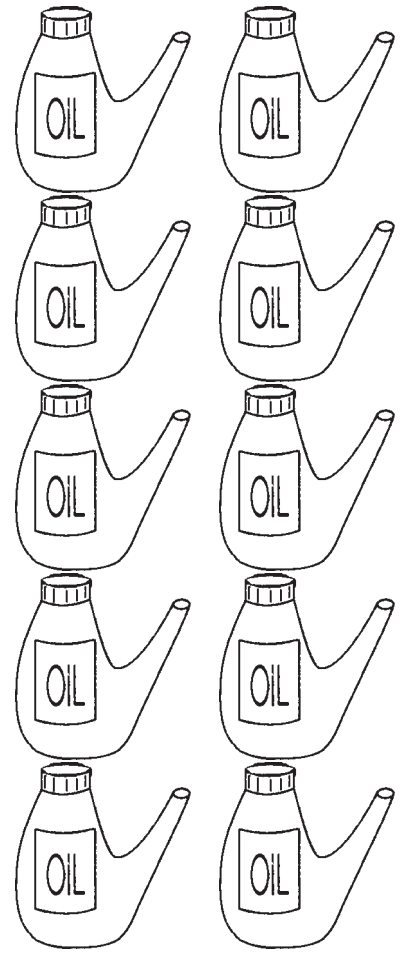
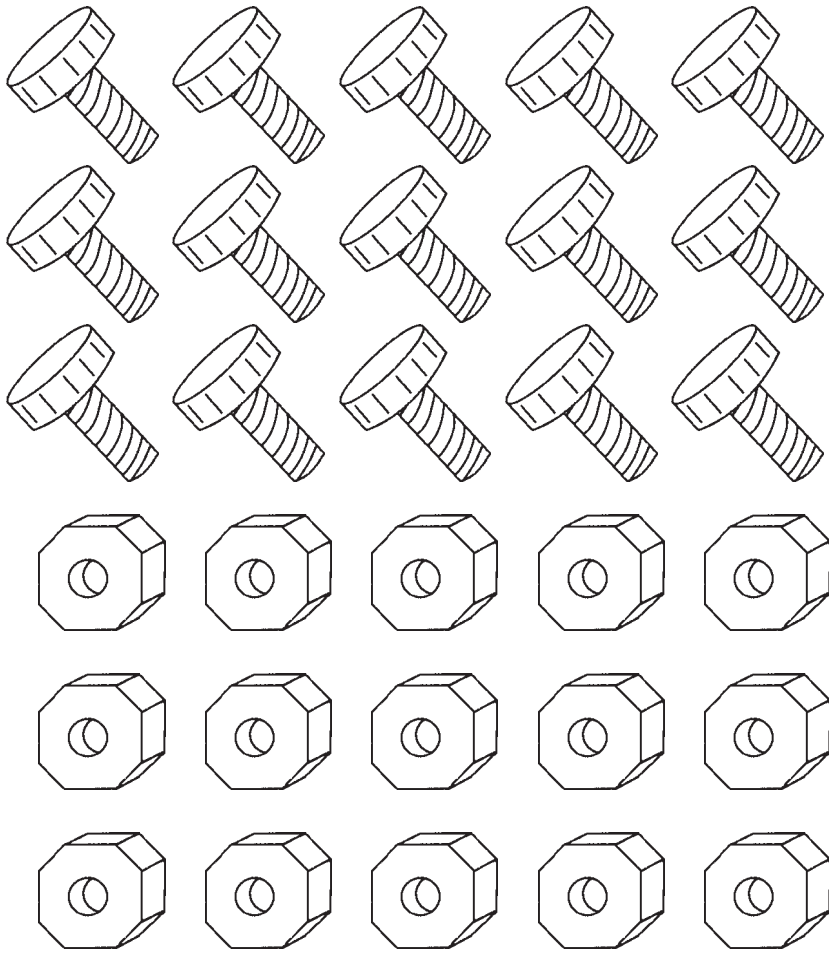

Build-a-Robot

Focus Areas

- shapes
- spatial concepts
- position concepts

Preparation

- Make duplicate copies of Build-a-Robot 1, 2, 3 & 4.
- Cut out the pieces.

Tip: Mark backs of each set of pieces differently for easy sorting.

Suggested Use

1. Before playing, review the shapes and practise describing them during a group construction.
2. To play, place a barrier between players. Players on each side of the barrier have:
 - a set of robot construction pieces
3. One player builds a robot with a selection of pieces and describes each part to the other player, who then builds an identical robot.
4. The barrier is then removed and the robots are compared. Players note any differences that occurred.
5. The game continues with the other player taking a turn to build a robot and give directions.

Variations

- **Colour** Colour the robot shapes or photocopy them onto coloured card or paper. Make extra copies of the shapes using different colours. This will increase the difficulty of the game. To make the game simpler, reduce the number of robot building pieces.
- **Taking Turns** Players can take turns to add pieces to a robot. Each player gives and receives directions until the robot is built. The barrier is then removed and the robots are compared.

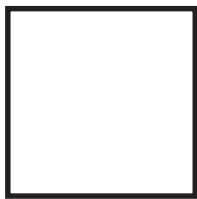
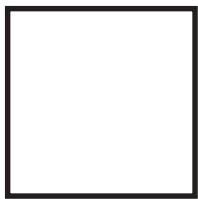
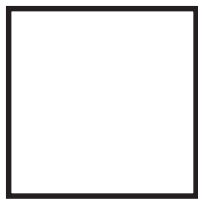
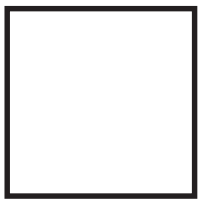
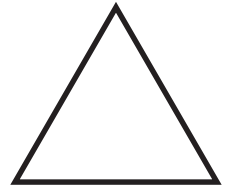
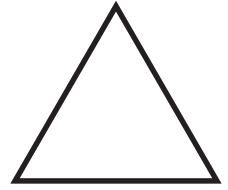
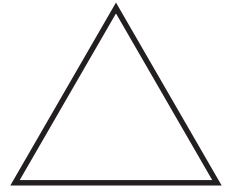
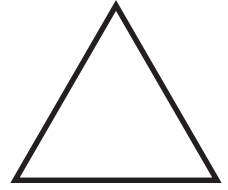
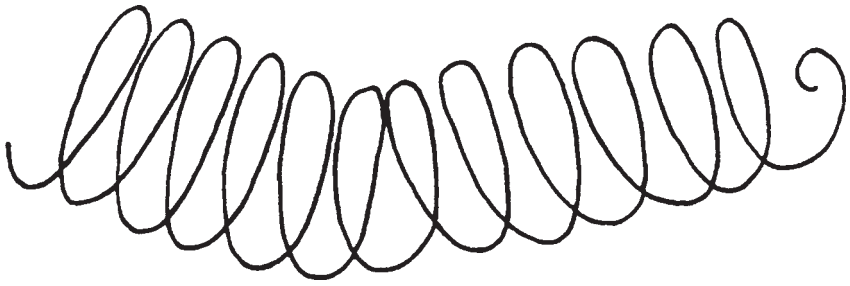
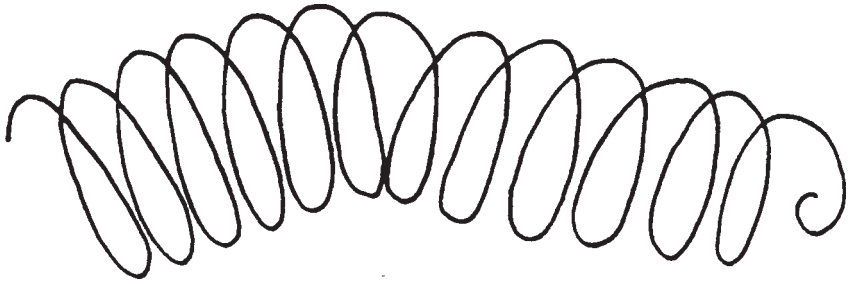
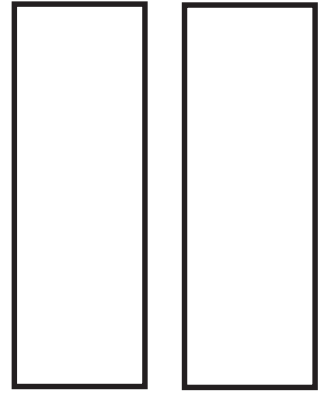
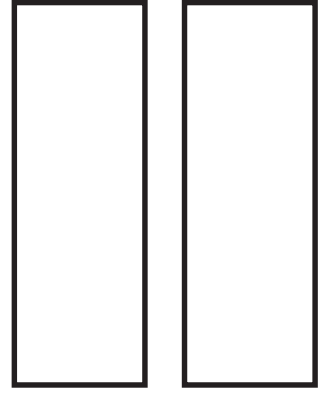
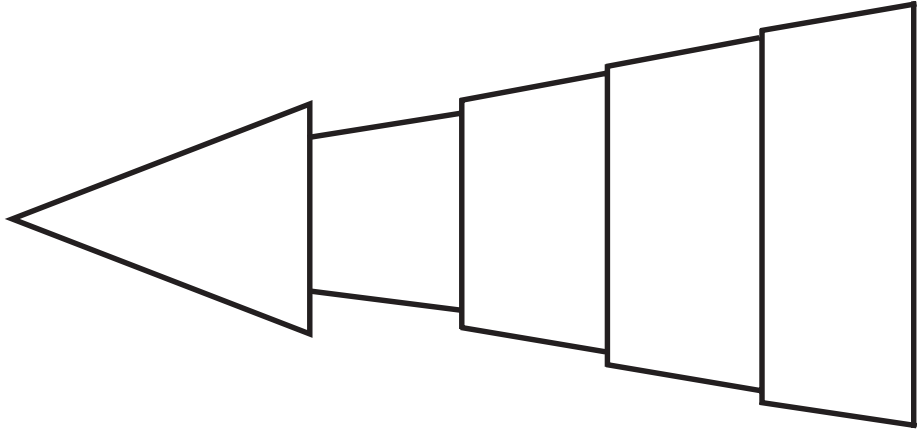
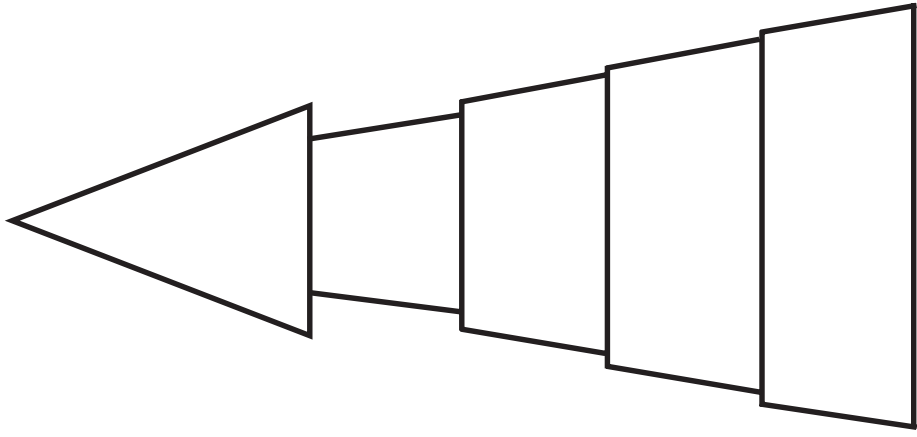

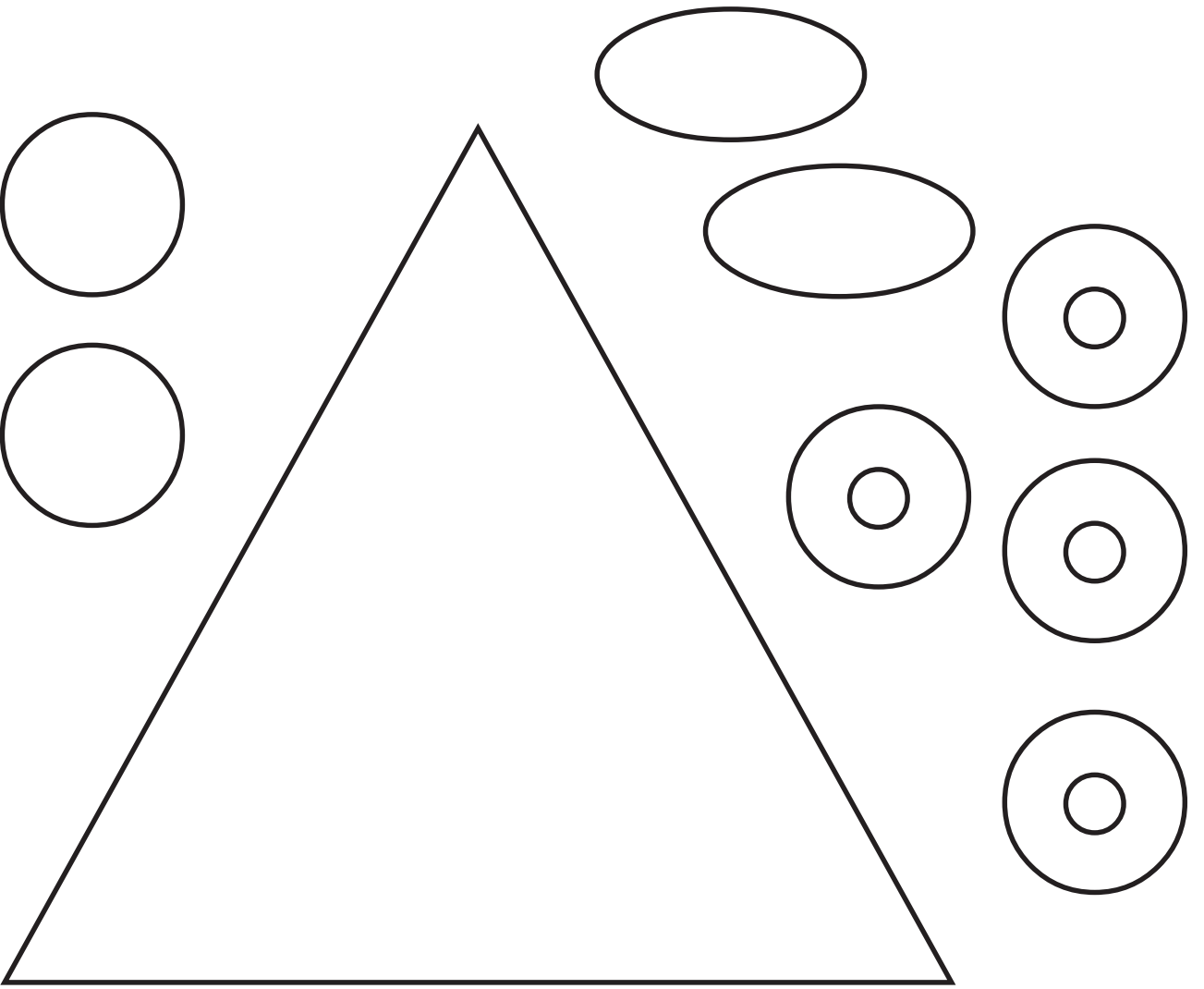
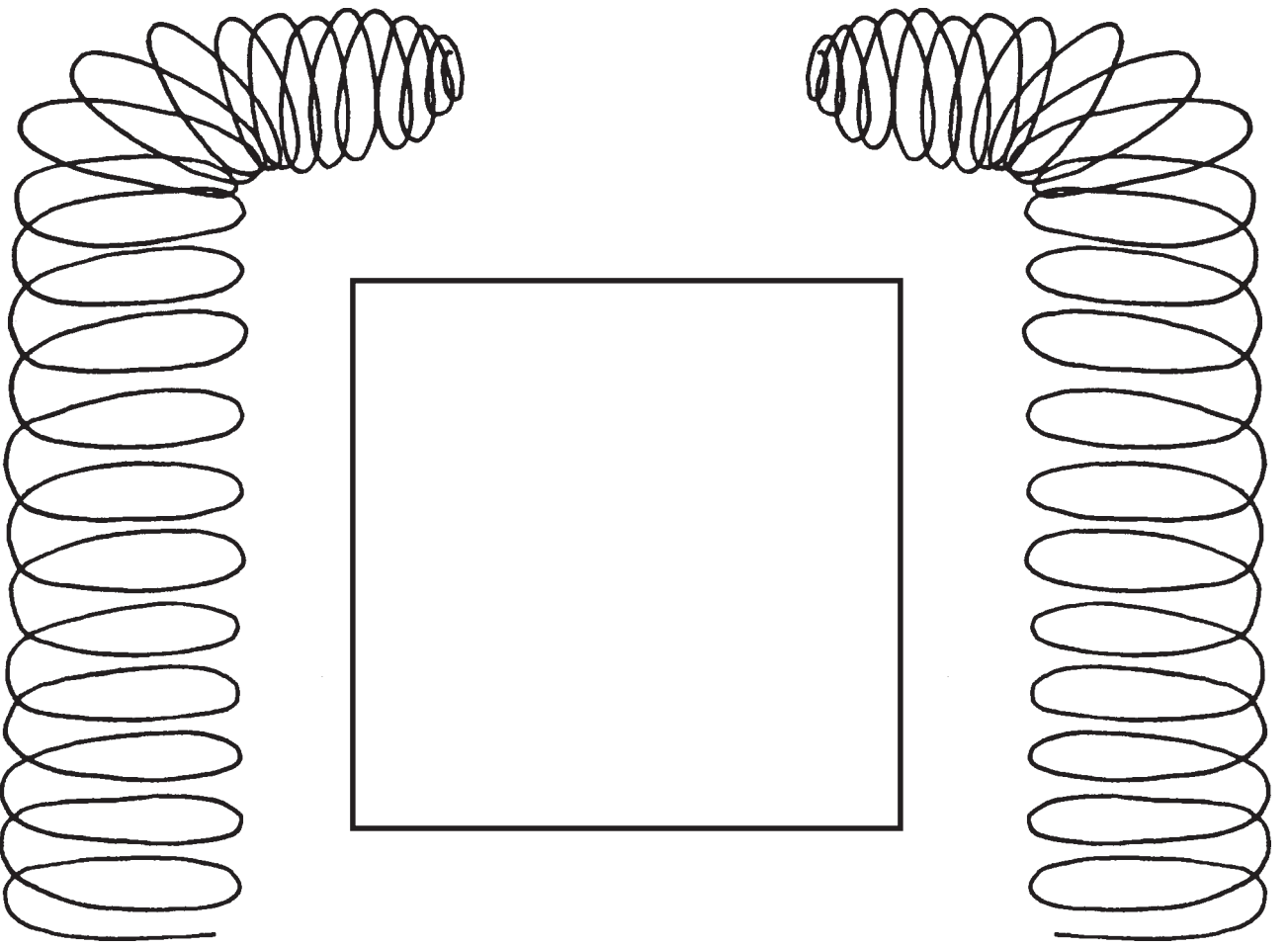

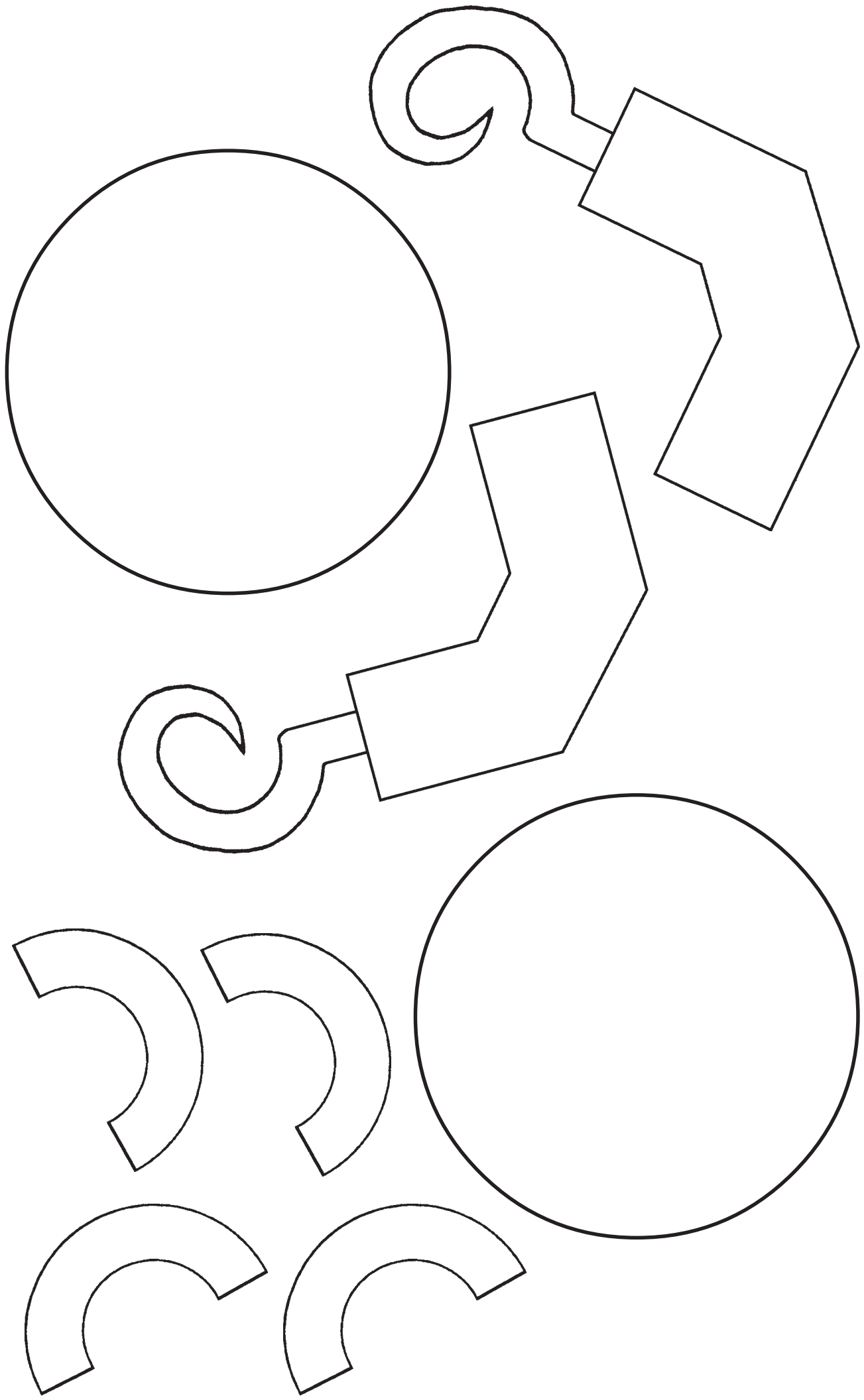

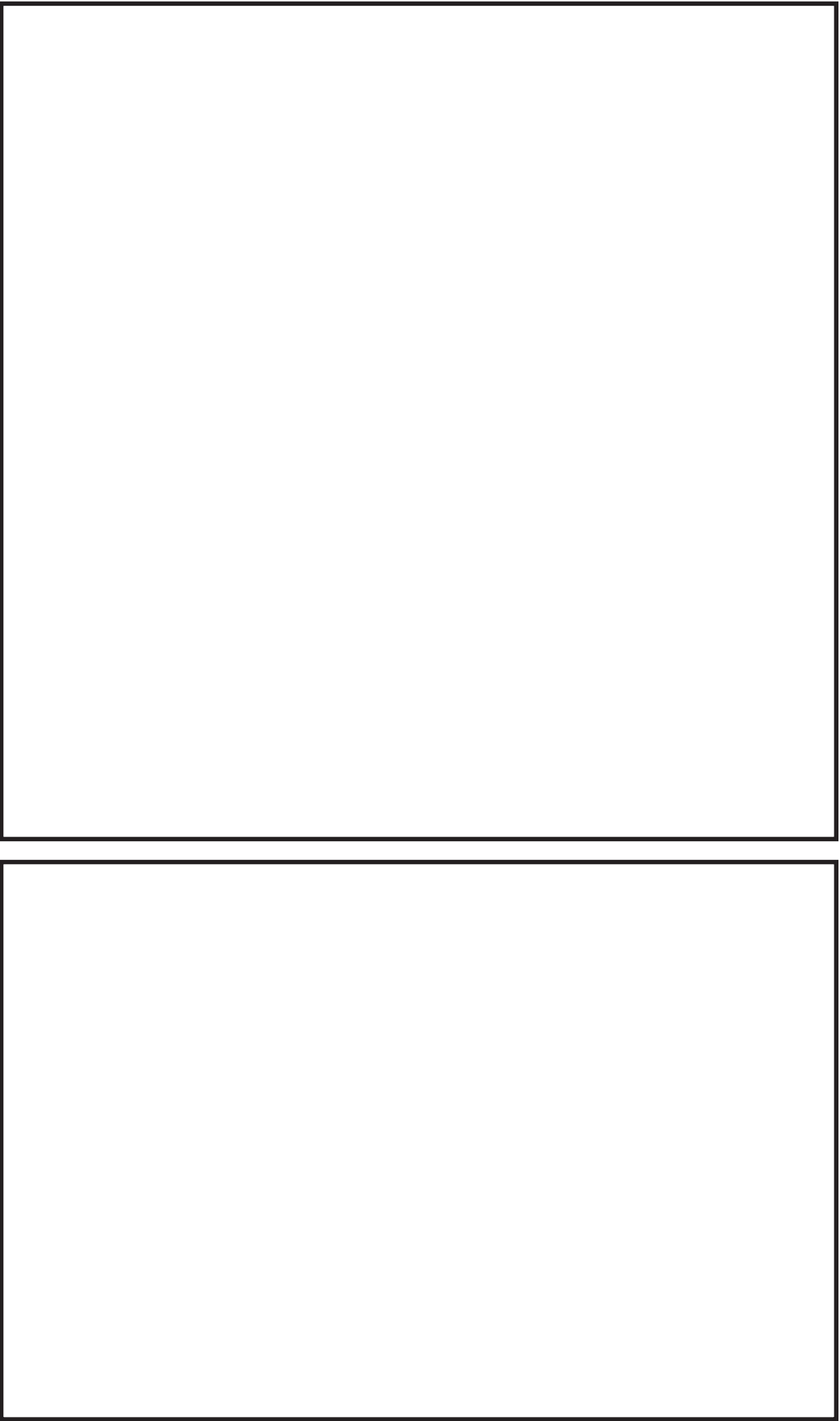

Robot Listen & Draw

Focus Areas

- language: description
- spatial concepts
- colour

Preparation

- Make duplicate copies of Robot Listen & Draw.

Suggested Use

1. Place a barrier between players. Players on each side of the barrier have:
 - the robot picture
 - a matching set of coloured pencils
2. Players take turns to draw something on the robot and then give directions so that the other player can draw an identical item in the same location. Ideas for additional drawn items could include body parts or words written in the speech balloon.
3. The barrier is then removed and the drawings are compared. Players note any differences that occurred.

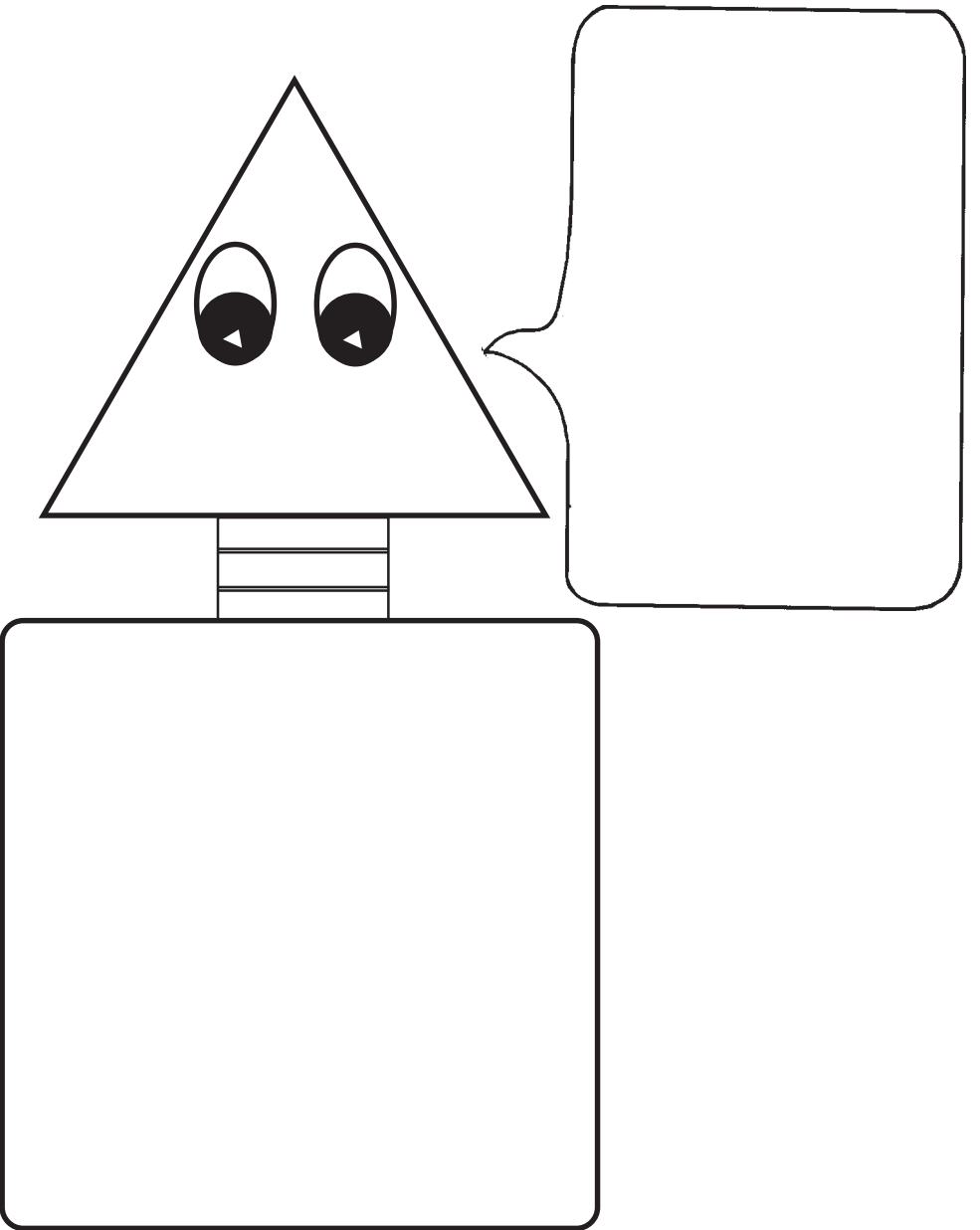

Robot Relatives

Focus Areas

- language: description
- number recognition
- attributes

Preparation

- Enlarge to A3 and make duplicate copies of 6 or 12 Grid. (See Grids p.125-6)
Write numbers you wish to focus on in each grid square.(See example below)
- Make duplicate copies of the Robot Relatives.
Note: To include colour as an attribute make additional copies onto coloured paper or card.
- Cut out robot cards.

Suggested Use

1. Place a barrier between players. Players on each side of the barrier have:
 - a grid
 - a set of robot cards
2. Players take turns to select a robot card and place it on grid while giving directions to the other player so they can place the same card in the same position, e.g. *“Place the robot with a square head, antennae and straight legs on number 32.”*
3. Players continue until all the grid areas are filled.
4. The barrier is then removed and the grids are compared. Players note any differences that occurred.

32	27	52
66	85	49

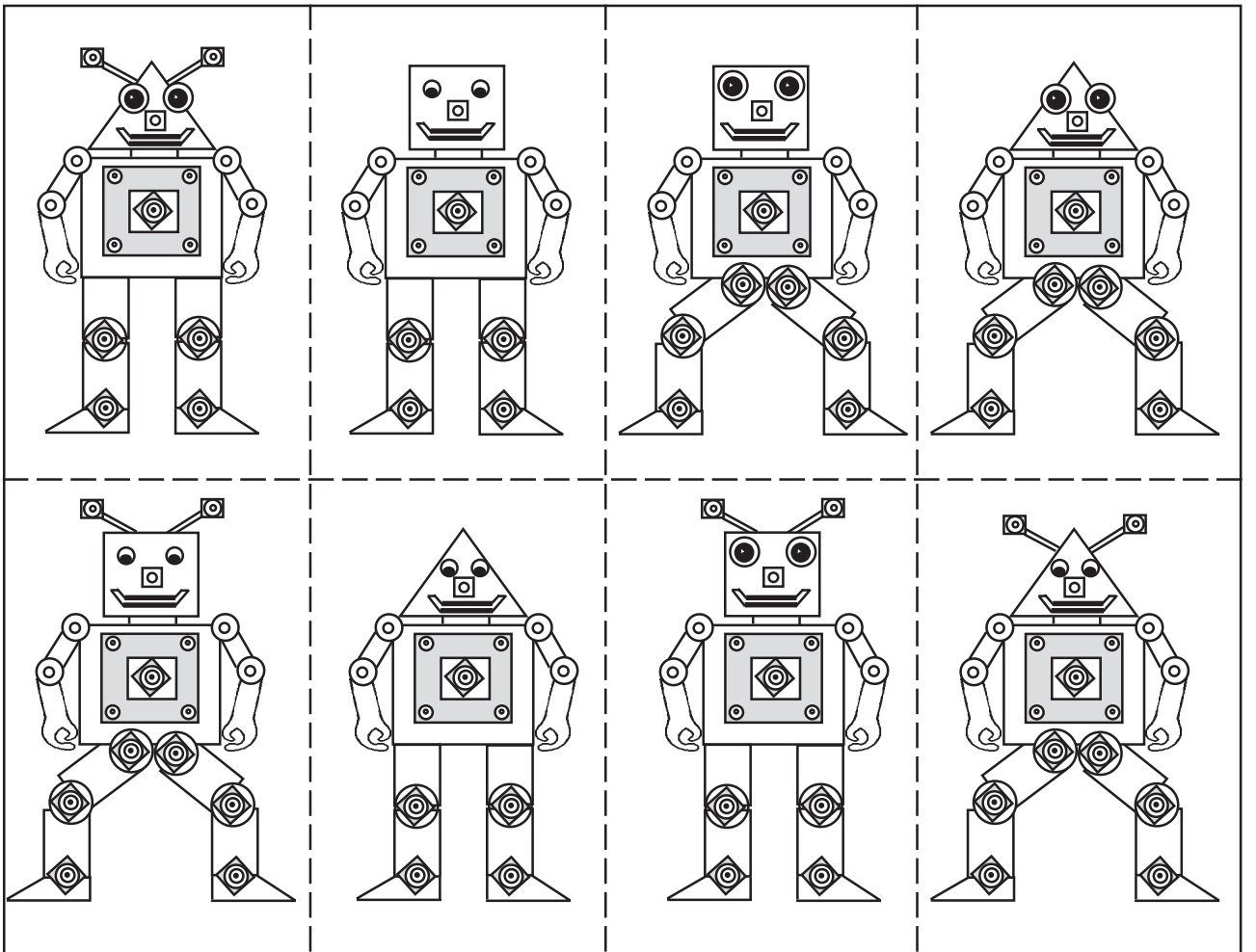
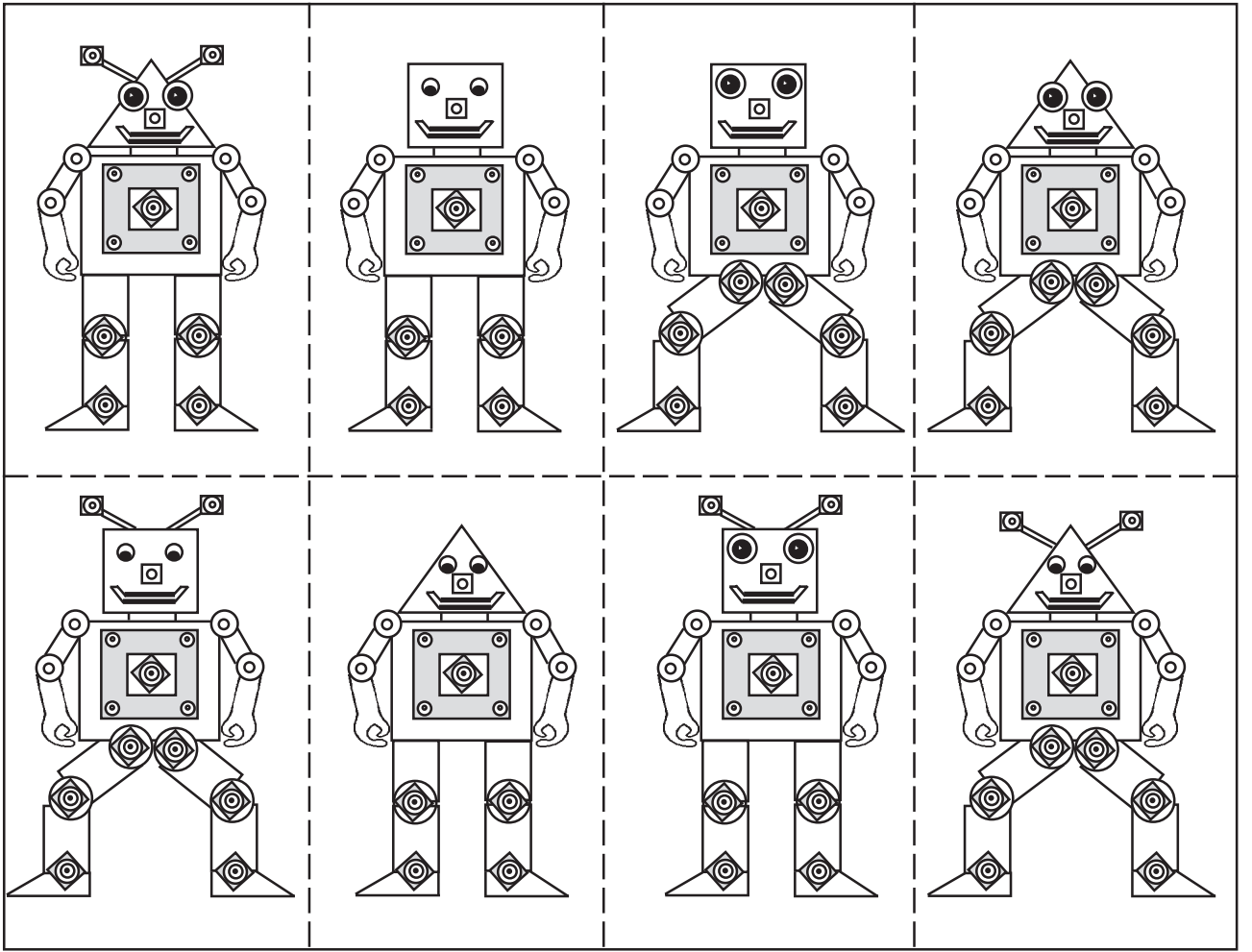

Animals Barrier Games

Farm Animals

Focus Areas

- language: description
- farm animals

Preparation

- Make duplicate copies of the Farm Scene.

Suggested Use

1. Place a barrier between players. Players on each side of the barrier have:
 - a farm scene
 - a matching set of coloured counters or blocks
2. Players take turns to give directions for placing a coloured counter on the scene, e.g. *“Put a yellow counter on the cat’s tail.”*
3. Players continue until all the counters are placed.
4. The barrier is then removed and the scenes are compared. Players note any differences that occurred.

Variations

- **Draw on the Scene** Use a matching set of coloured pencils. Players give directions for adding items to the scene or colouring parts of the scene, e.g. *“Colour the mouse pink.”*



Farm Number Cards

Focus Areas

- language: names of animals
- number: counting, addition
- position concepts

Preparation

- Use blocks or similar to create 2 to 4 enclosures, e.g.
- Make duplicate copies of the Farm Number Cards.
- Cut out cards.

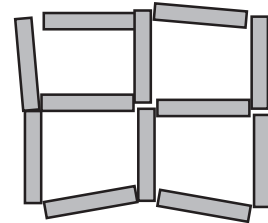

Tip: Mark backs of each card set differently for easy sorting.

Suggested Use

1. Place a barrier between players. Players on each side of the barrier have:
 - a group of enclosures ('paddocks') built from blocks
 - a set of farm number cards
2. Players may wish to sort the cards before starting in order to make them easy to locate.
3. Players take turns to select several cards and place them in a 'paddock' area while giving directions to the other player so they can place the same cards in the same area, e.g. *"Place the 4 pigs, 3 geese and 5 horses in the first paddock."*
4. Players continue until all the 'paddock' areas are filled.
5. The barrier is then removed and the 'paddock' areas are compared. Players note any differences that occurred.

Variations

Equivalent Numbers Build 2 enclosures. The first player creates a set of animals in the first 'paddock' and gives instructions to the second player to copy. The second player then has a turn to select cards for the other 'paddock' but the total number of animals must equal the number in the first 'paddock'. After the barrier is removed and 'paddocks' have been compared, the second player then creates the initial set of animals and the first player must create the equivalent set.

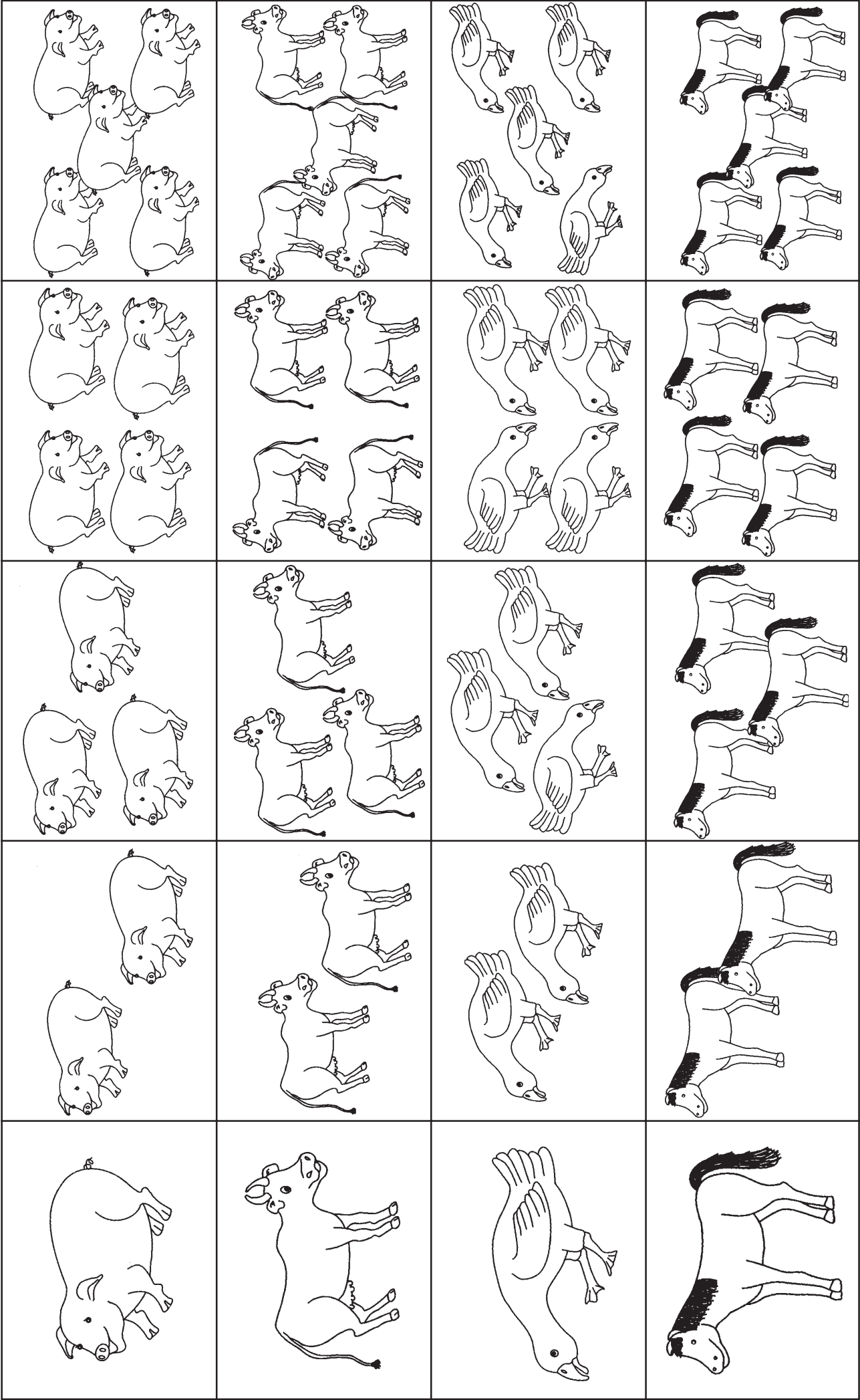

Piggy Pattern Block

Focus Areas

- language: pattern block shape names
- spatial concepts
- position concepts

Preparation

- Copy the Piggy Pattern.
- Copy the Pattern Block Shapes (or use commercial Pattern Blocks).
- Cut out pattern blocks shapes.

Suggested Use

1. Before playing, let children use the pattern blocks shapes for making their own designs. Discuss names for the shapes. Give students practise at describing their designs and copying others designs.
2. Place a barrier between players. You need:
 - a piggy pattern
 - a set of pattern block shapes
3. Players may wish to sort the blocks before starting in order to make them easy to locate.
4. One player has the piggy pattern, the other player has the pattern block shapes.
5. The player with the piggy pattern describes to the other player how to place the pattern block shapes to create the piggy pattern.
6. The barrier is then removed and the piggy patterns are compared. Players note any differences that occurred.

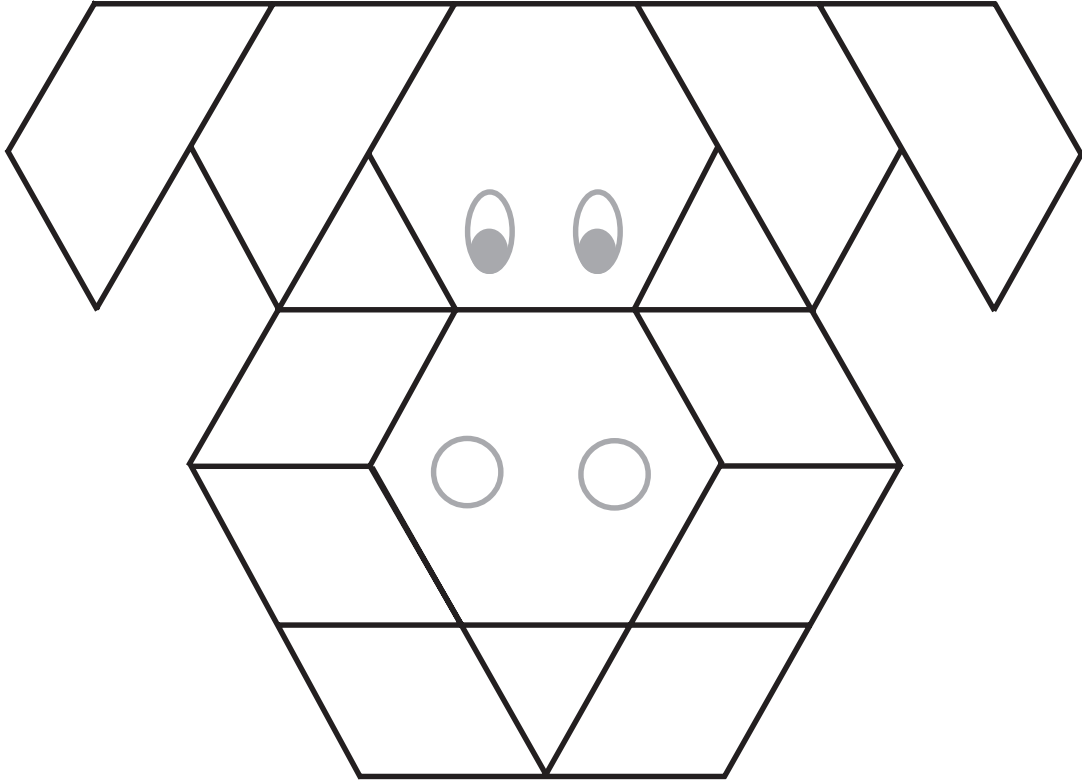

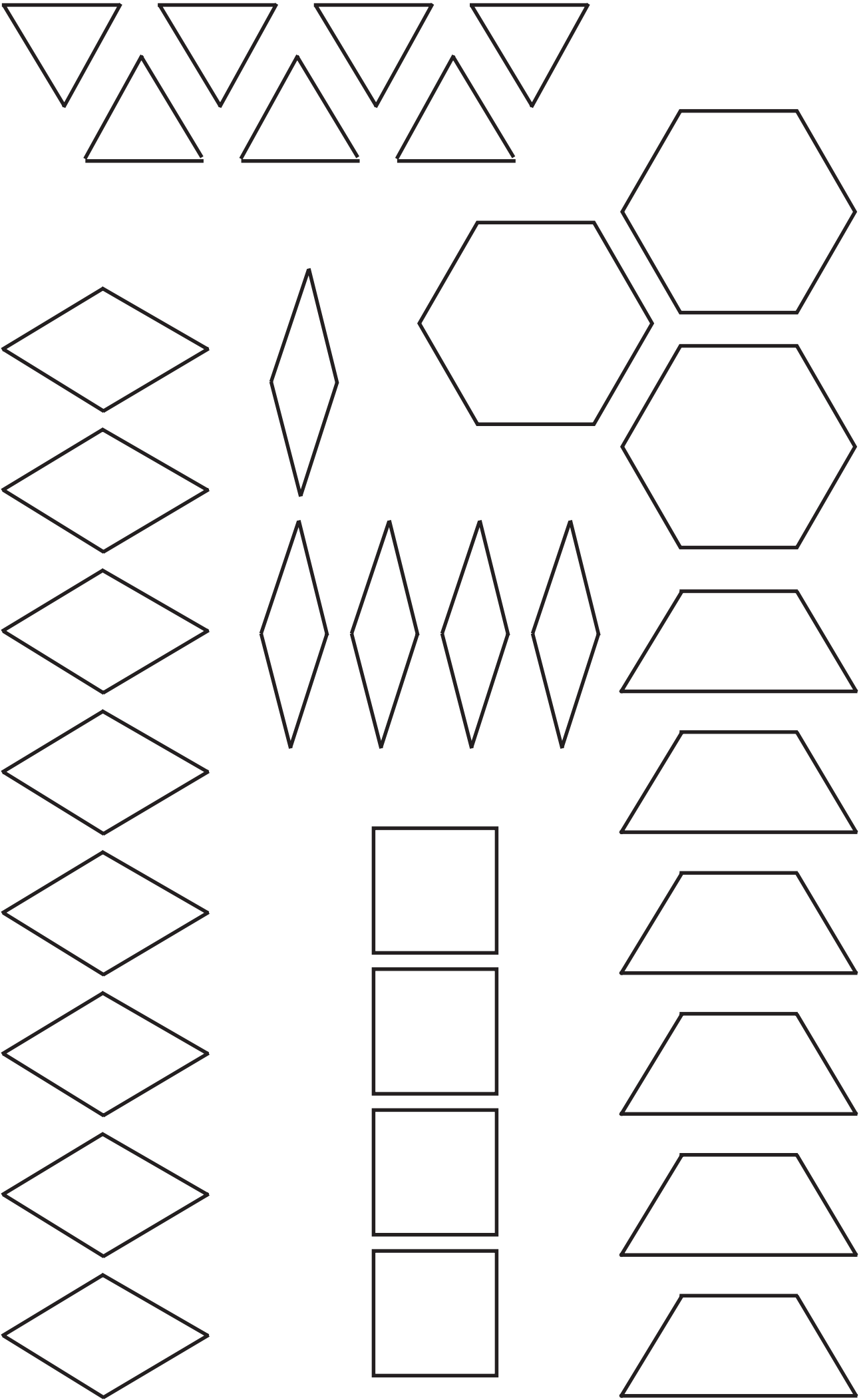

Jungle Animals

Focus Areas

- language: description
- jungle animals

Preparation

- Make duplicate copies of the Jungle Scene.

Suggested Use

1. Place a barrier between players. Players on each side of the barrier have:
 - a jungle scene
 - a matching set of coloured pencils
2. Players take turns to give directions for colouring or drawing on the scene, e.g. *“Colour the butterflies body red.”*
3. Players continue until each player has had several turns at giving and receiving directions.
4. The barrier is then removed and the scenes are compared. Players note any differences that occurred.

Variations

- **Blocks on the Scene** Use a matching set of coloured blocks or counters. Players give directions for placing blocks on the scene, e.g. *“Put a green block on the crocodile’s head.”*



Mountain Animals

Focus Areas

- language: description
- mountain animals
- position concepts

Preparation

- Make duplicate copies of the Mountain Scene.
- Make a copy of the Mountain Animals.
- Cut out animals.

Suggested Use

1. Place a barrier between players. Players on each side of the barrier have:
 - a mountain scene
 - a set of mountain animals
2. One player places the animals on the scene and gives directions to the other player so that they can place the same animal in the same location.
3. The barrier is then removed and the scenes are compared. Players note any differences that occurred.
4. The game continues with the barrier being replaced and the other player placing animals on the scene and giving directions.

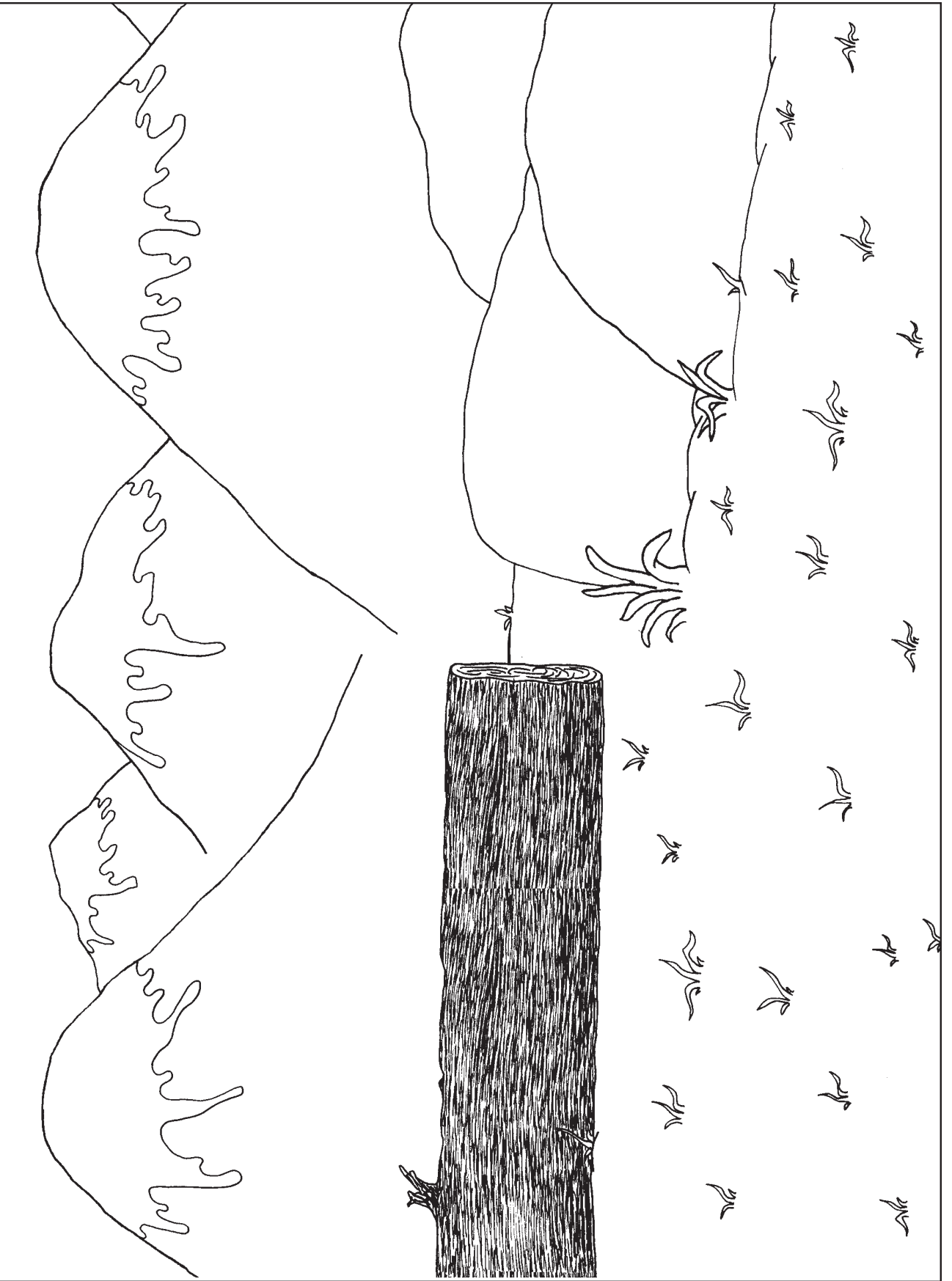

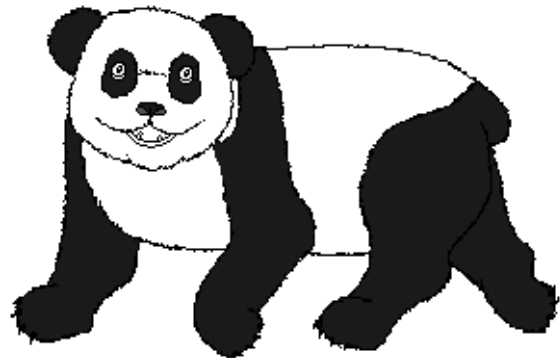
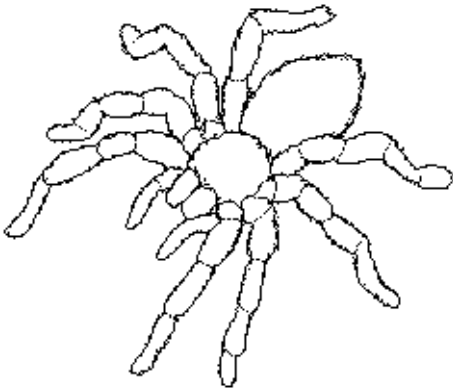
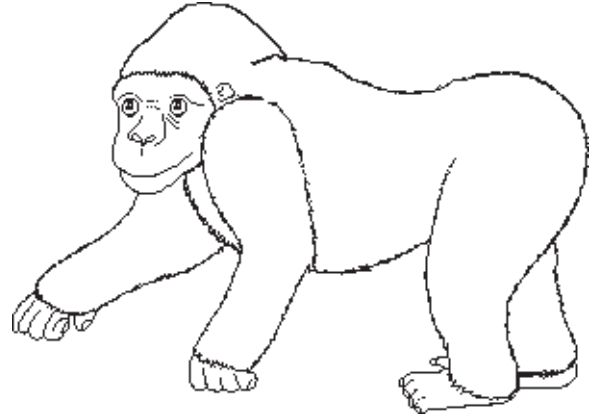
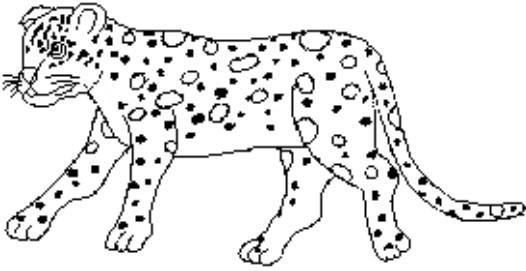
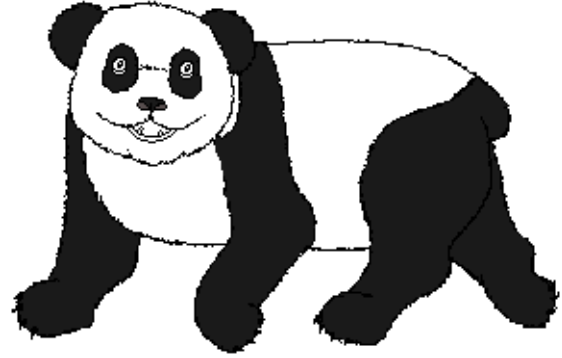
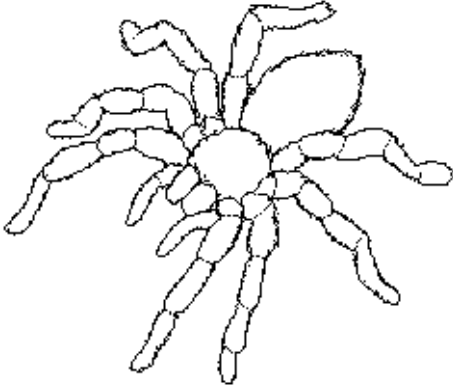
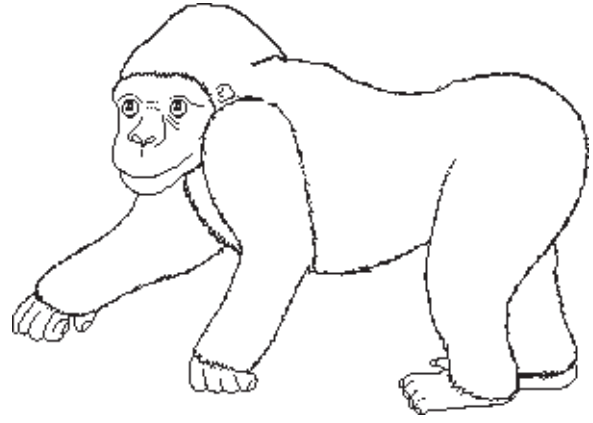
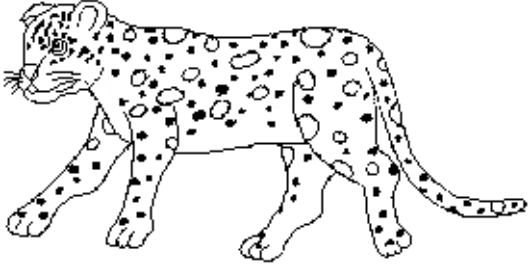

Australian Animals

Focus Areas

- language: description
- Australian animals

Preparation

- Make duplicate copies of the Australian Scene.

Suggested Use

1. Place a barrier between players. Players on each side of the barrier have:
 - an australian scene
 - a matching set of small coloured shapes or similar
2. Players take turns to give directions for placing items on the scene, e.g. *“Put the red square on the platypus.”*
3. Players continue until all each player has had several turns at giving and receiving directions.
4. The barrier is then removed and the scenes are compared. Players note any differences that occurred.



Aussie Animal Pattern Block

Focus Areas

- language: pattern block shape names
- spatial concepts
- position concepts

Preparation

- Copy the Kangaroo or Emu Pattern.
- Copy the Pattern Block Shapes on p.95 (or use commercial Pattern Blocks).
- Cut out pattern blocks shapes.

Suggested Use

1. Before playing, let children use the pattern blocks shapes for making their own designs. Discuss names for the shapes. Give students practise at describing their designs and copying others designs.
2. Place a barrier between players. You need:
 - a kangaroo or emu pattern
 - a set of pattern block shapes
3. Players may wish to sort the blocks before starting in order to make them easy to locate.
4. One player has the kangaroo or emu pattern, the other player has the pattern block shapes.
5. The player with the kangaroo or emu pattern describes to the other player how to place the pattern block shapes to create the pattern.
6. The barrier is then removed and the patterns are compared. Players note any differences that occurred.

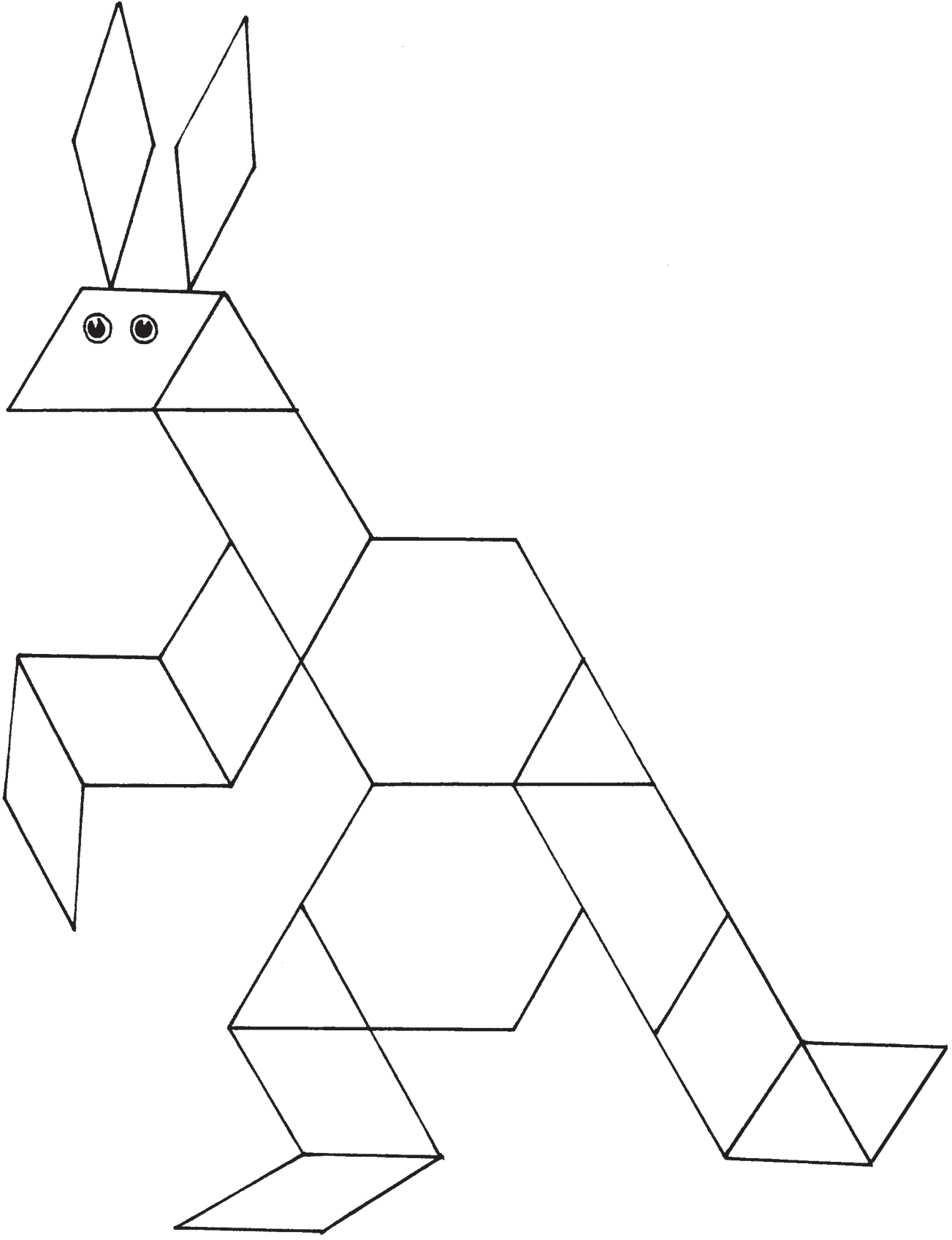

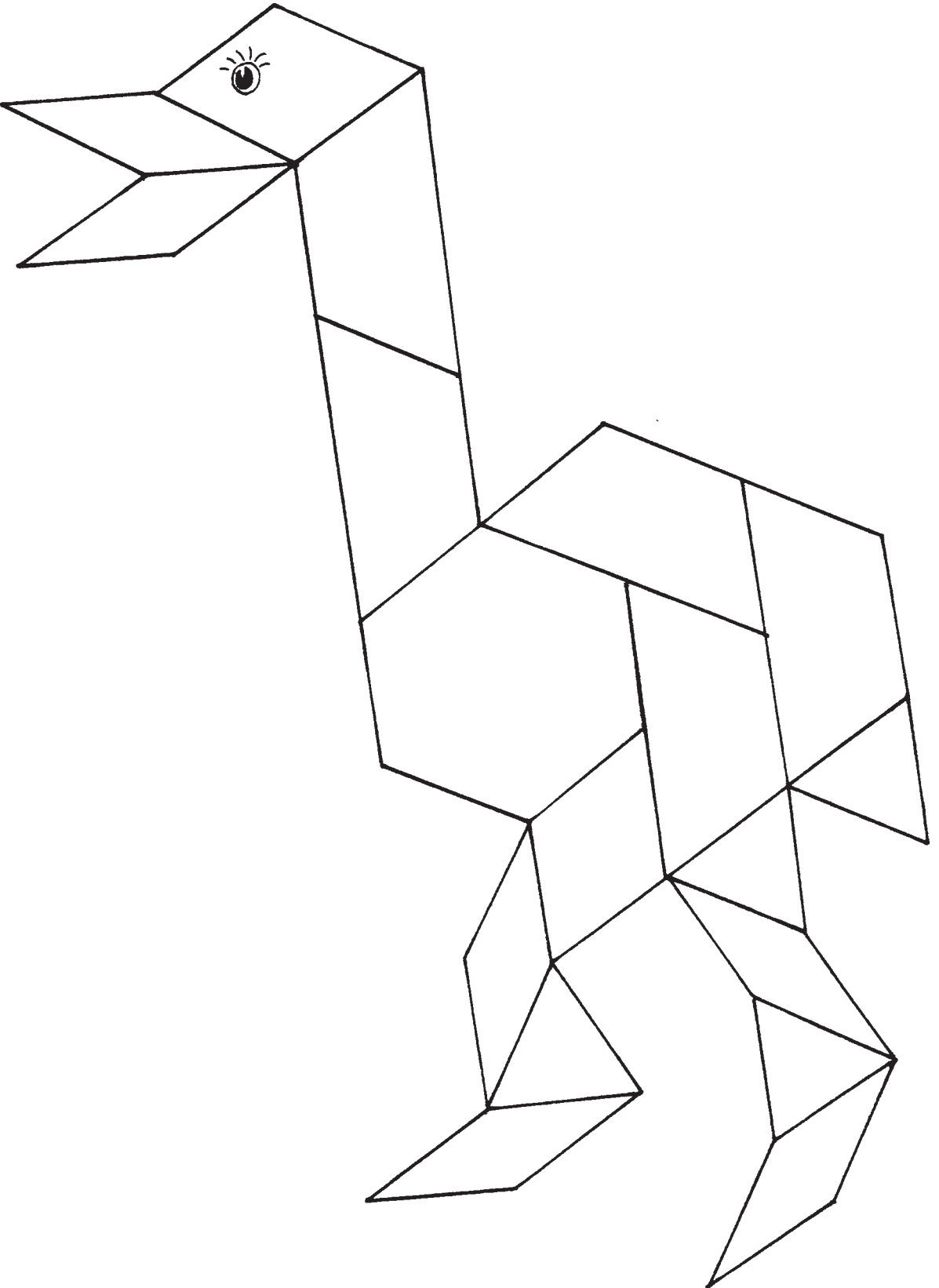

Fish Number Cards

Focus Areas

- language: description
- number: counting, addition
- shape

Preparation

- Enlarge and make duplicate copies of a 12 Grid. (see Grids p.126).
- Mark different shapes in each grid area.
- Make duplicate copies of the Fish Number Cards.
- Cut out cards.

Tip: Mark backs of each card set differently for easy sorting.



Suggested Use

1. Place a barrier between players. Players on each side of the barrier have:
 - a 12 grid
 - a set of fish number cards
2. Players may wish to sort the cards before starting in order to make them easy to locate.
3. Players take turns to select a card and place it on a shape in the grid, e.g. *“Put one spotty fish on the small triangle.”*
4. Players continue until all the grid areas are filled.
5. The barrier is then removed and the grids are compared. Players note any differences that occurred.

Variations

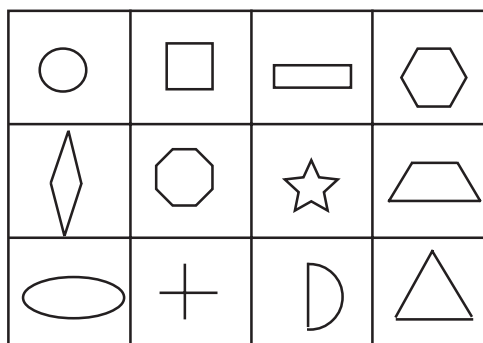
Colour Colour the fish cards or photocopy them onto coloured paper to add colour as an additional attribute.

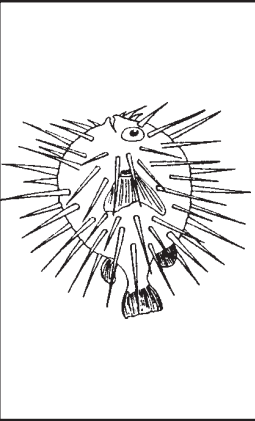
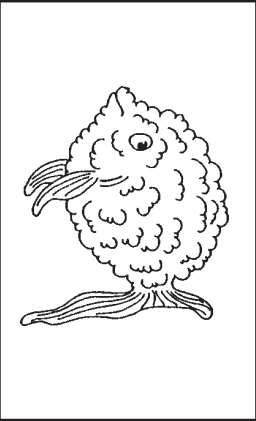
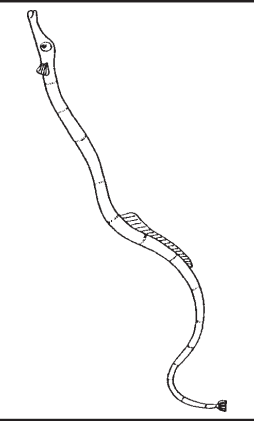

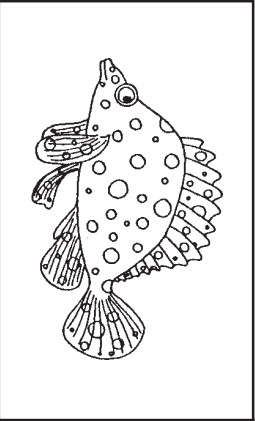
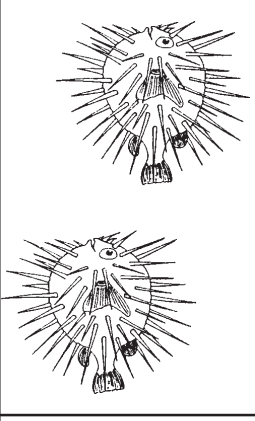
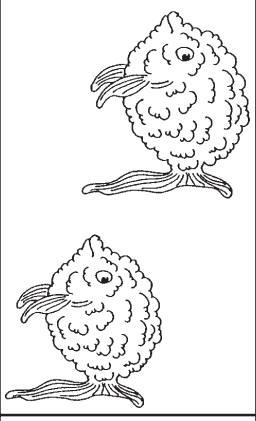
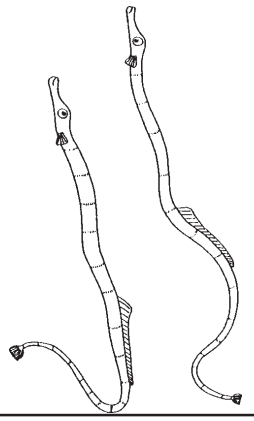
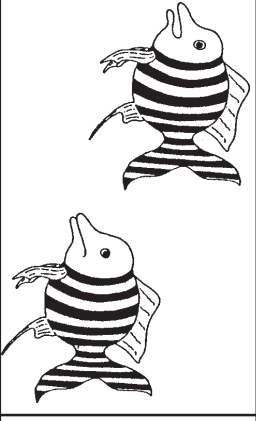
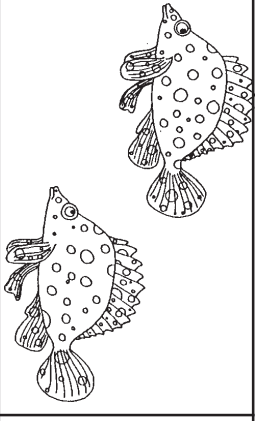
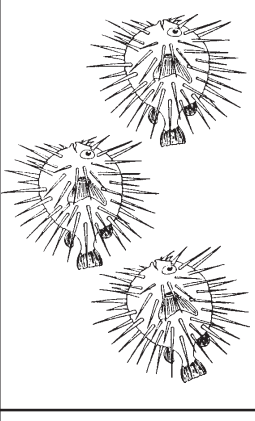
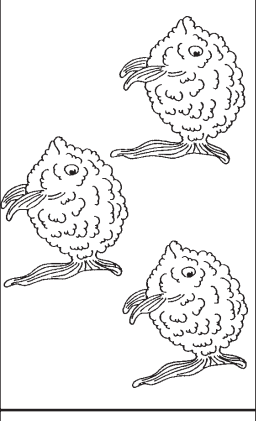
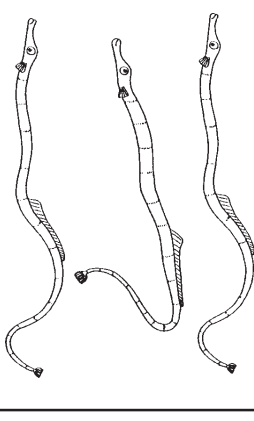
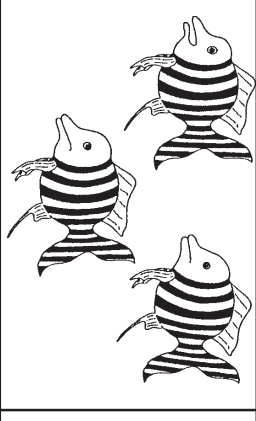
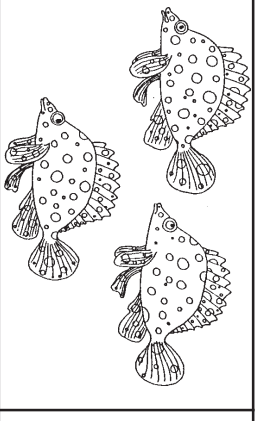
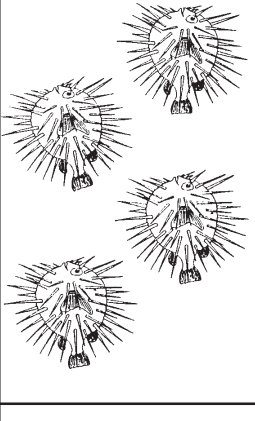
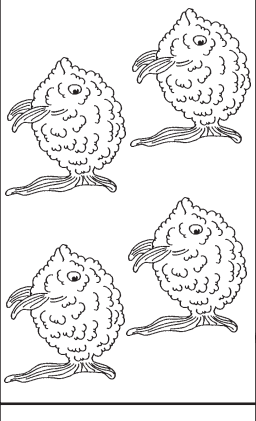
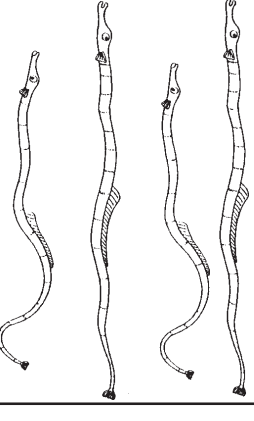
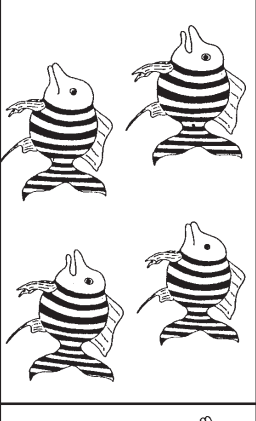
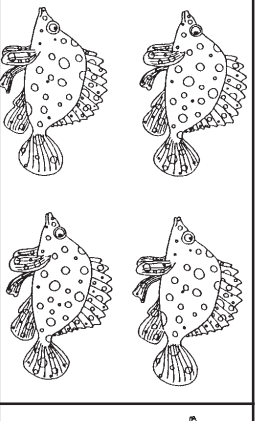
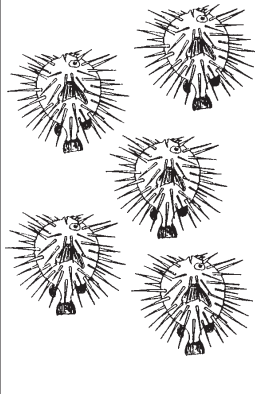
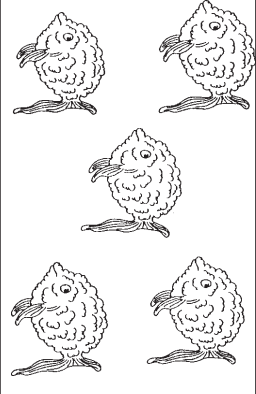
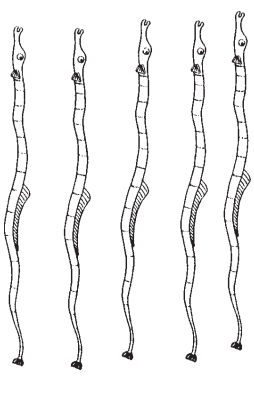
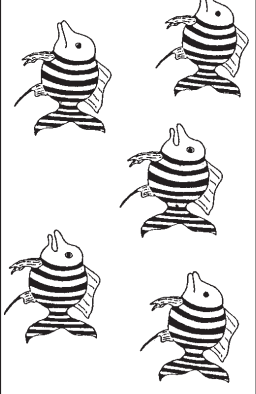
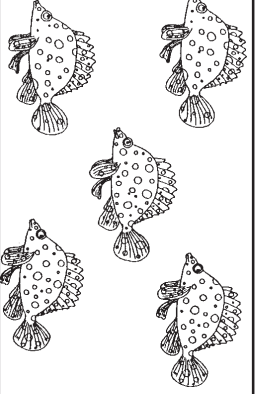
Treasure on the Beach

Focus Areas

- language: description
- position concepts

Preparation

- Make duplicate copies of the Beach Scene.

Suggested Use

1. Place a barrier between players. Players on each side of the barrier have:
 - a beach scene
 - coloured pencils
2. One player marks the position of the “treasure” with a small cross on their scene.
3. The other player asks questions to guess the location of the treasure, e.g. *“Is the treasure beside the crab?”*
4. The first player answers the question using degrees of “*warm*”, “*hotter*”, “*very hot*” as the guesses get closer to the mark or “*cool*”, “*cooler*”, “*cold*” as the guesses move away from the location of the “treasure”.
5. When the “treasure” has been located, players change roles and the second player marks the location of the “treasure” on their scene, while the first player asks questions to guess the location.
6. Scenes can be reused several times using a different coloured pencils for each turn.

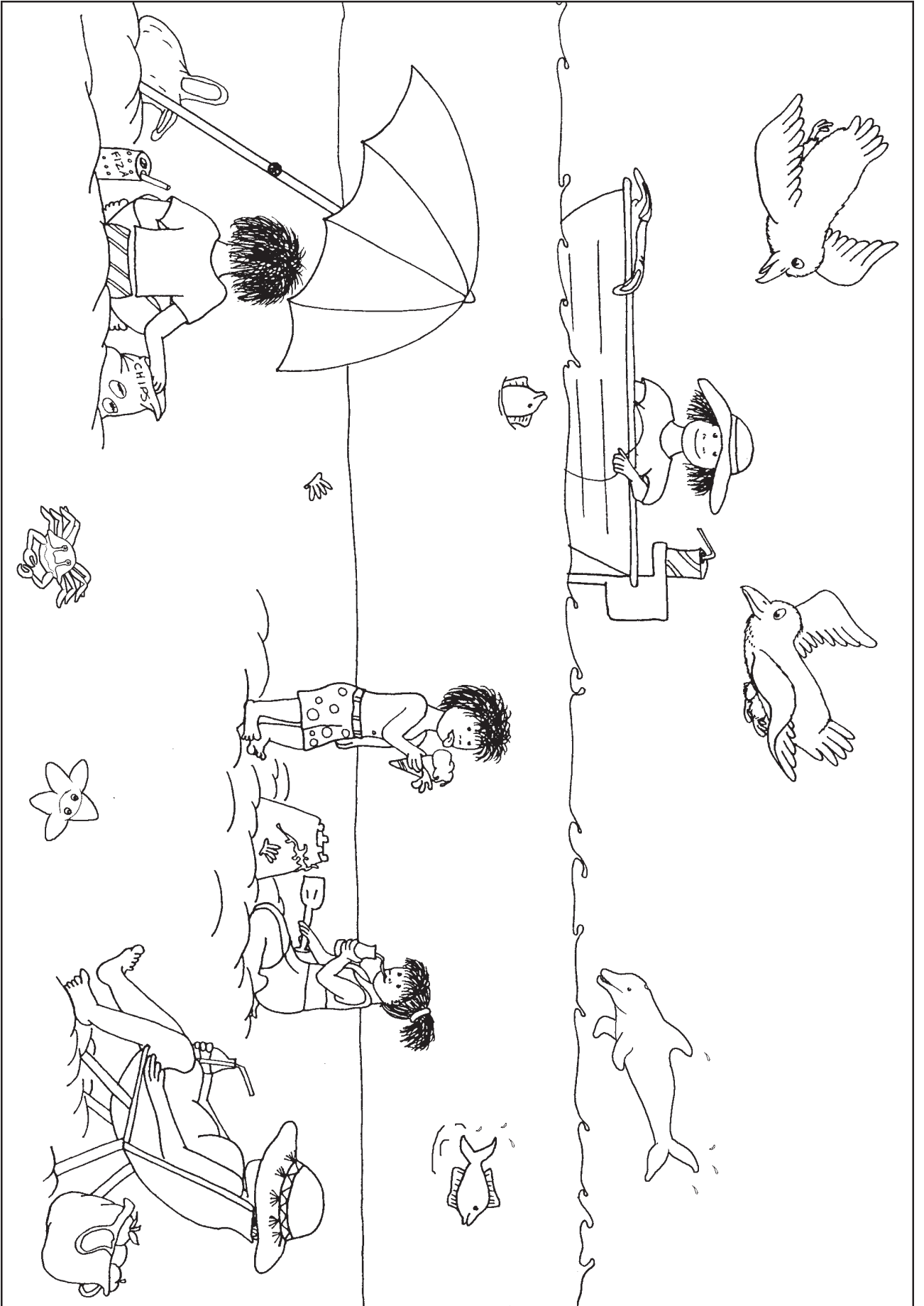

Sea Creatures

Focus Areas

- language: description
- attributes
- spatial concepts

Preparation

- Make duplicate copies of Sea Scene.
- Make duplicate copies of the Sea Creatures.
- Cut out sea creatures.

Tip: Mark backs of each sea creature set differently for easy sorting.

Suggested Use

1. Place a barrier between players. Players on each side of the barrier have:
 - a sea scene
 - a set of sea creatures
2. Players may wish to sort the sea creatures before starting in order to make them easy to locate.
3. Players take turns to place a sea creature on the sea scene and describe its location to the other player who tries to place the same creature in the same position. *“Place the bumpy fish in the cave.”*
4. After players have had several turns at giving and receiving directions, remove the barrier and compare scenes. Players note any differences that occurred.

Variations

Colour Photocopy the sea creatures onto different coloured paper and add to the set to increase the range of attributes.

Scene Colour Have children colour parts of the scene in identical colours to make items easier to place.

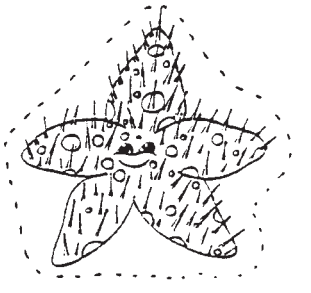
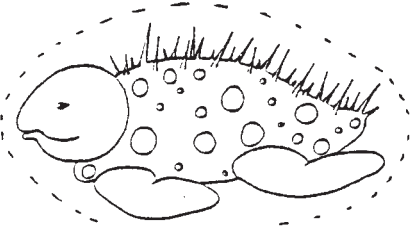
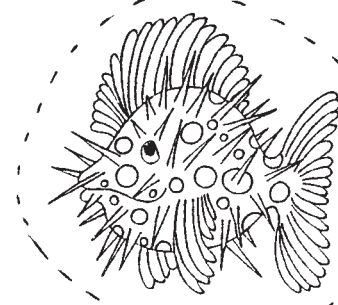
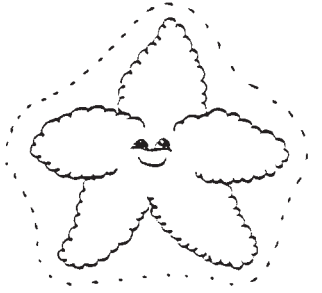
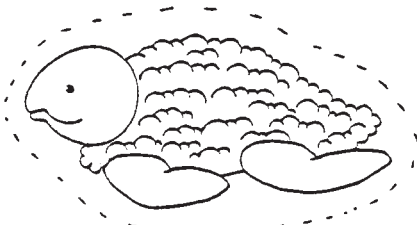
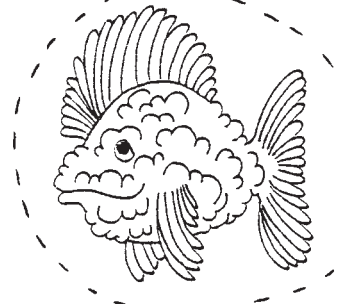
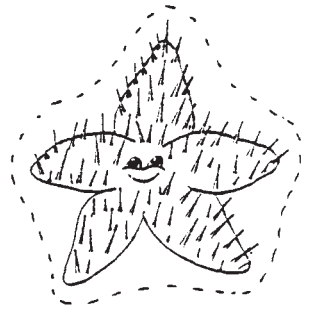
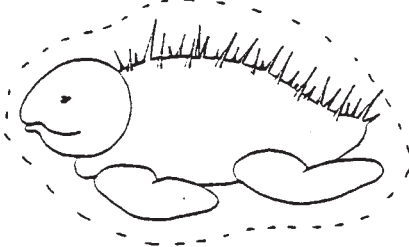
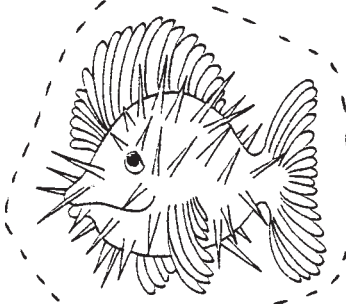
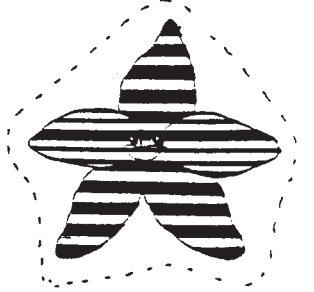
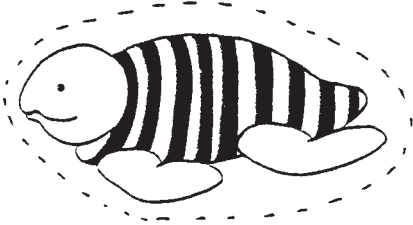
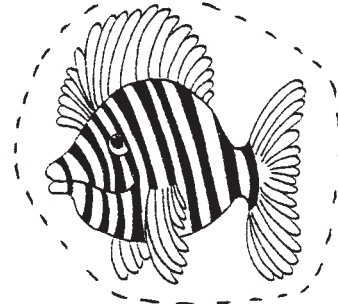
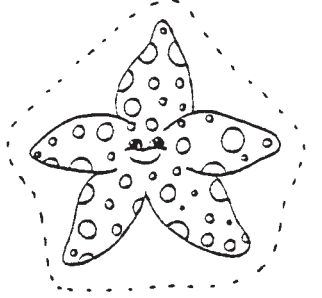
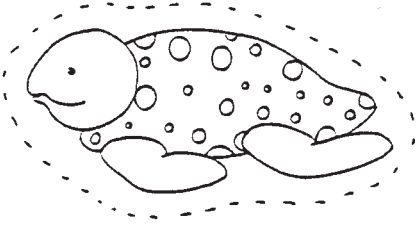
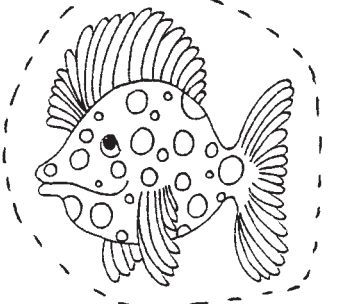
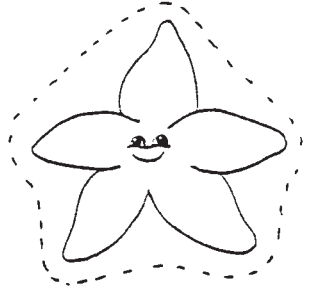
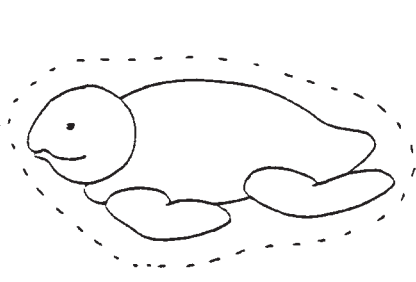
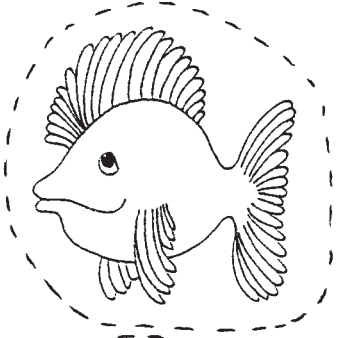

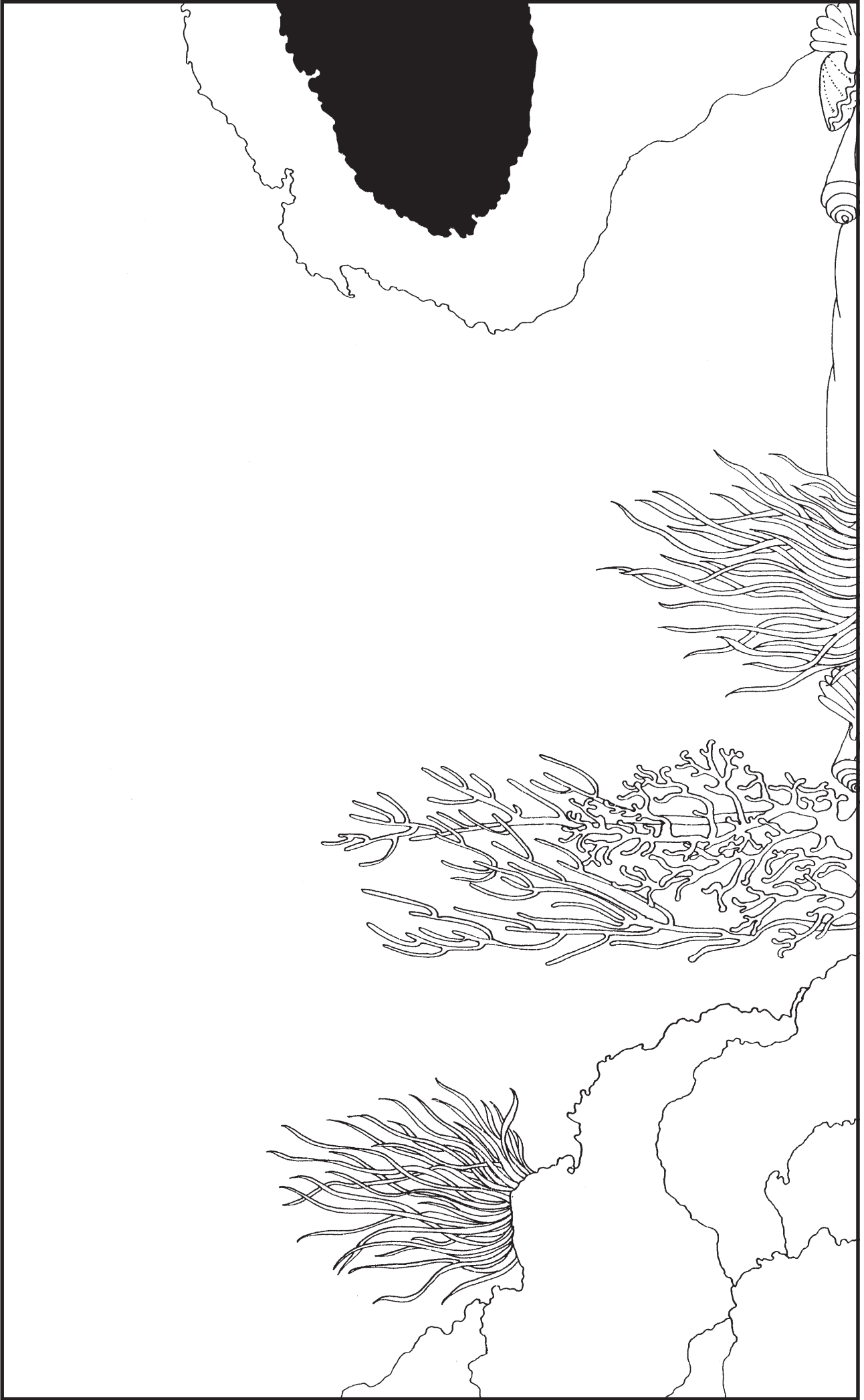

Spotted Caterpillar

Focus Areas

- colour
- ordinal number

Preparation

- Make duplicate copies of the Caterpillar & Spots.
- Colour the spots. Use 5 different colours and colour 5 spots with each colour.
- Cut out the spots.
- Note: Coloured counters could be used instead of spots.

Suggested Use

1. Place a barrier between players. Players on each side of the barrier have:
 - a caterpillar
 - a set of coloured spots
2. Players take turns to place a spot on the caterpillar's body giving directions to their partner to place the same coloured spot on the same body segment, e.g. *"Put a red spot on the second part of the caterpillar's body."*
3. The game continues until each player has had several turns at giving and receiving directions.
4. The barrier is then removed and the caterpillars are compared. Players note any differences that occurred.

Variations

Colour Colour the segments of the caterpillar's body in different colours to simplify the placement of spots, e.g. *"Put a red spot on the blue part of the caterpillar's body."*

Number Butterflies

Focus Areas

- colour
- number: counting
- position concepts

Preparation

- Enlarge to A3 and make duplicate copies of the Flower Grid.
- Colour the flowers of each row in 4 different colours, e.g.
colour the top row: red, blue, yellow, purple,
colour the bottom row: yellow, red, purple, blue.
- Make duplicate copies of the Number Butterflies.
- Cut out butterfly cards.

Suggested Use

1. Place a barrier between players. Players on each side of the barrier have:
 - a flower grid
 - a set of butterfly cards
2. Players take turns to place a butterfly card on the flower grid, e.g. *“Put a butterfly with 6 spots on the yellow flower in the second row.”*
3. The game continues until the grid is filled.
4. The barrier is then removed and the flower grids are compared. Players note any differences that occurred.

Variations

Colour Colour the spots on the butterfly cards in different colours or photocopy the butterflies onto different coloured paper or card to make number sets in different colours.

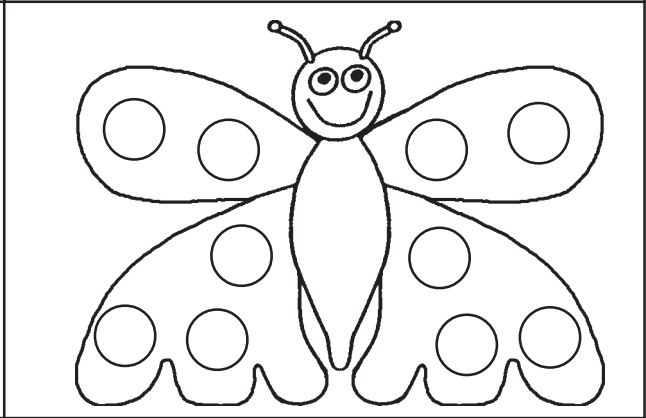
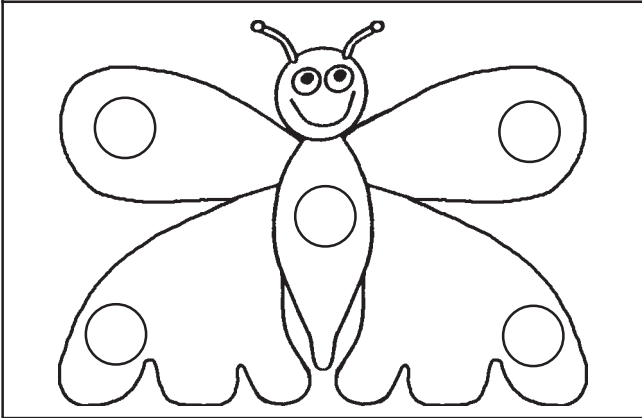
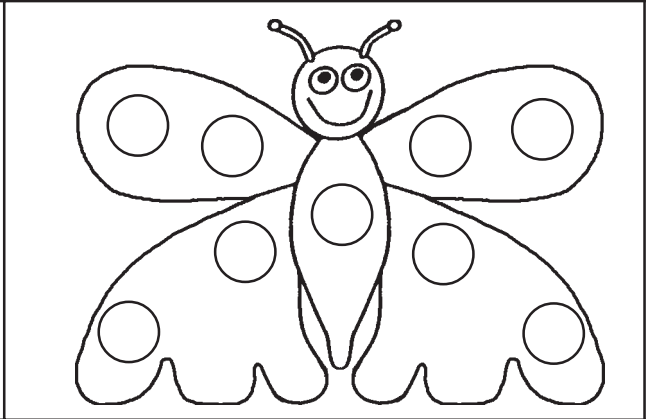
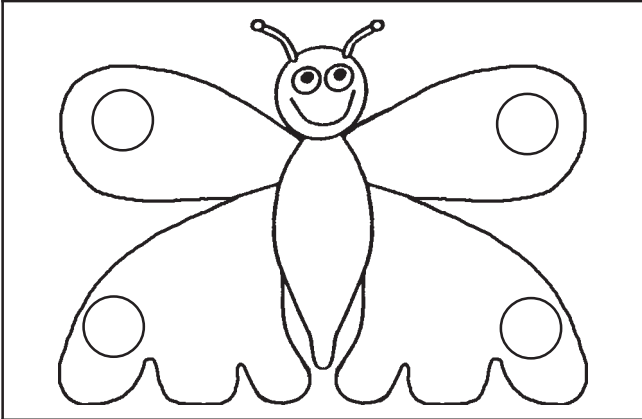
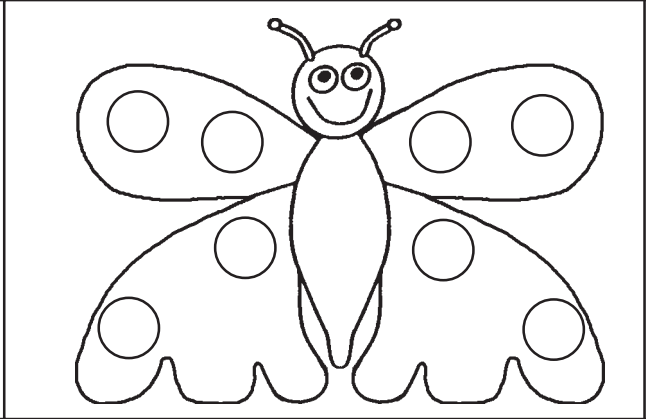
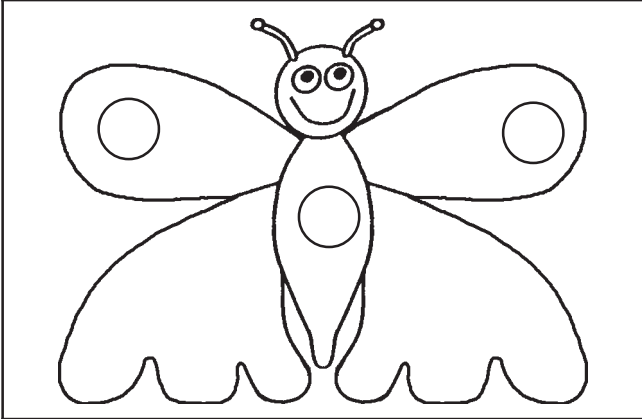
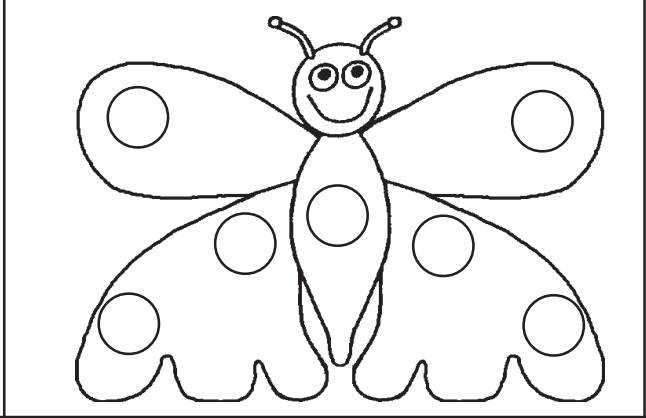
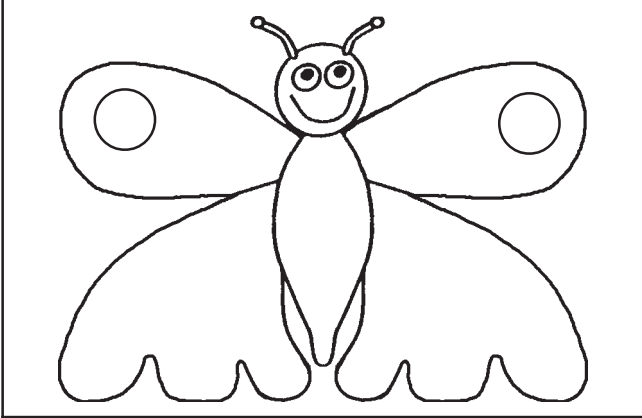
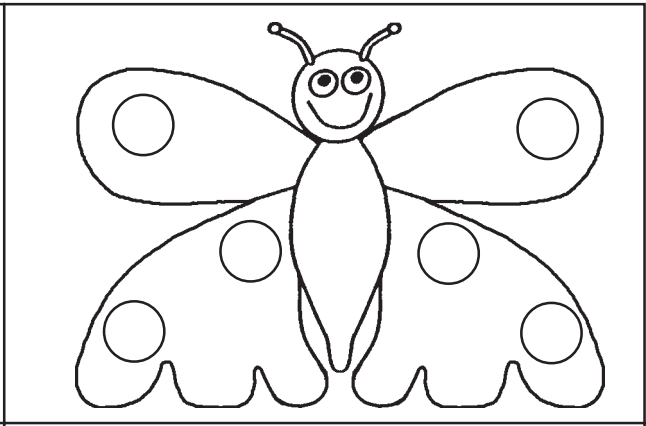
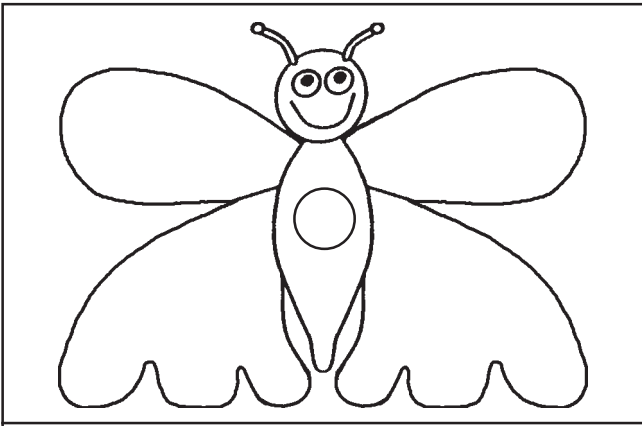

Enlarge to A3 size when copying

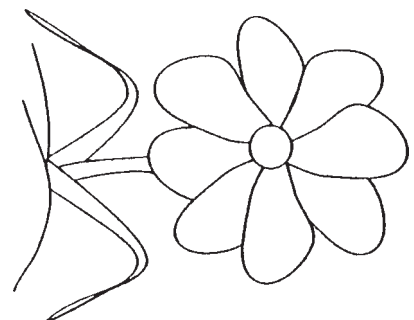
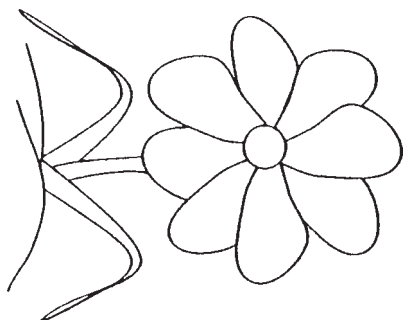
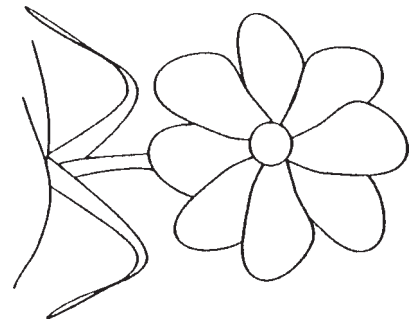
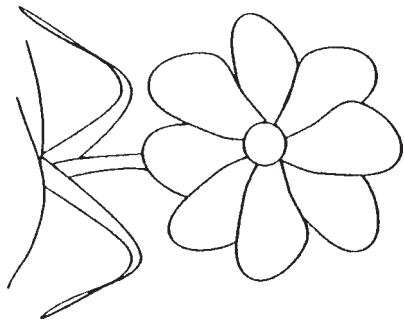
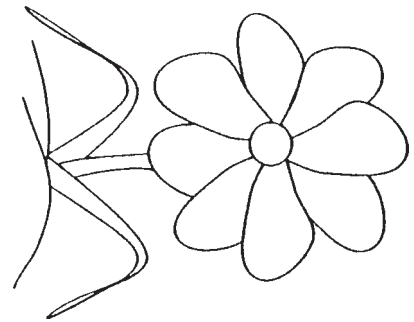
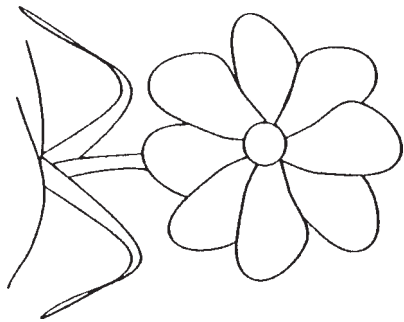
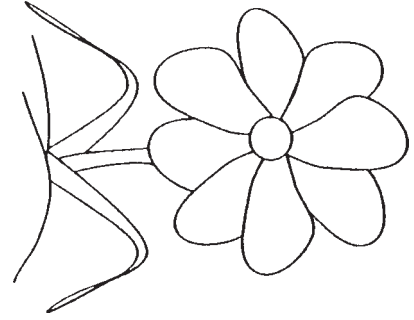
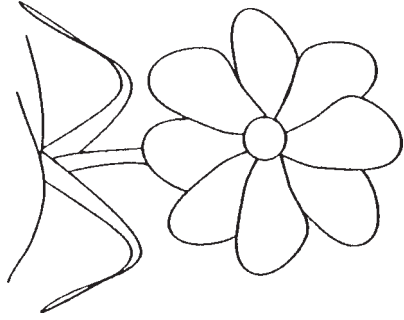

Dinosaur Map

Focus Areas

- map coordinates
- addition

Preparation

- Make duplicate copies of the Dinosaur Map.
You may wish to enlarge it on the photocopier.

Suggested Use





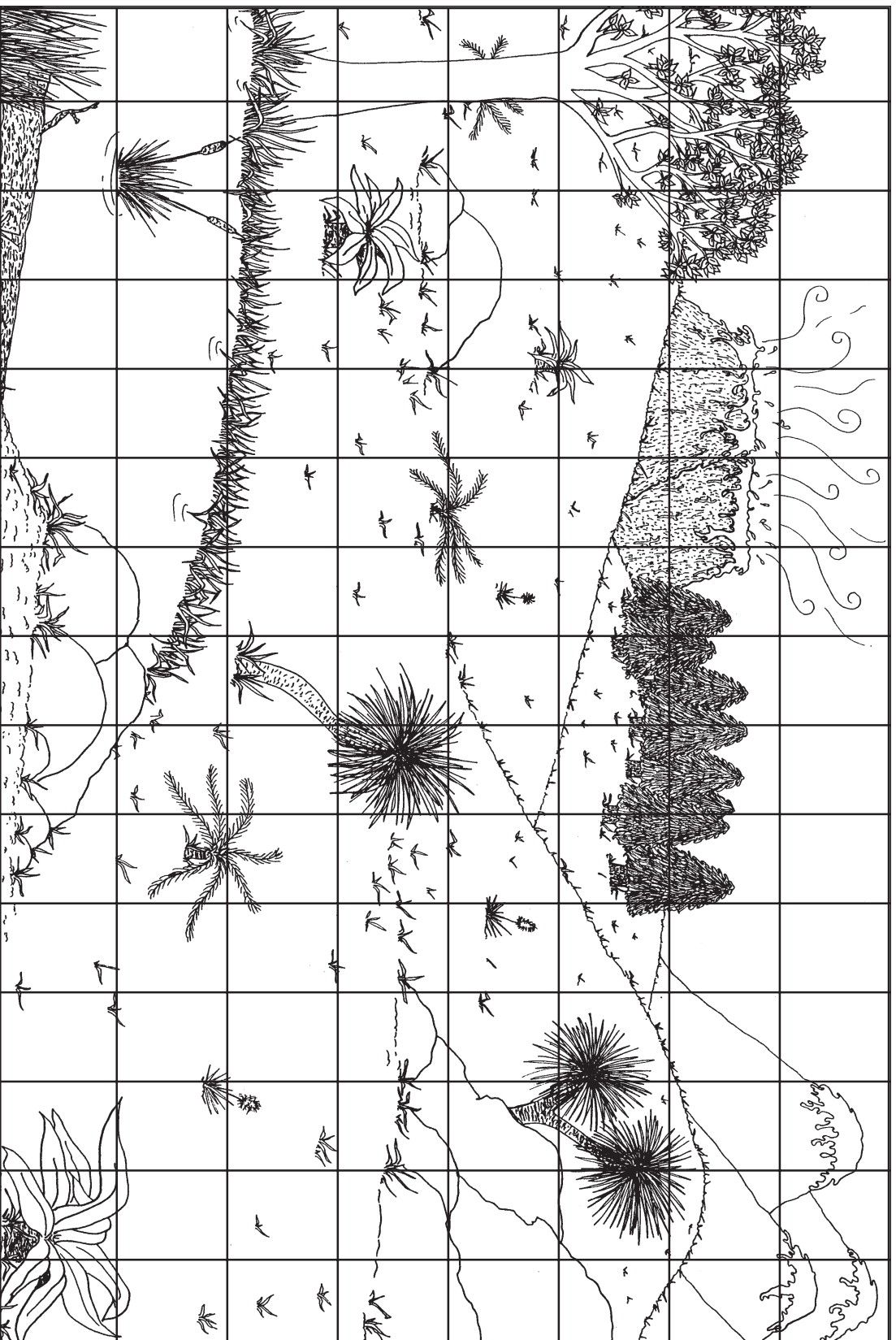







1. Before playing, provide children with the scenario of using a time machine to travel back to the time of the dinosaurs. To survive you need shelter, food and tools to make fire and hunt with.
2. Place a barrier between players. Players on each side of the barrier have:
 - a dinosaur map
 - a pencil
3. Players begin by plotting the letters onto the map area:
 - S for shelter (3)
 - T for tools (3)
 - F for food (4)
 - D for dinosaurs (4)
4. Players take turns to call out a coordinate, e.g. *“Is there anything on J6?”* The other player responds by saying *“miss”* if nothing was in that area or naming the item if a letter was marked in the area, e.g. *“You have some tools.”*
If an item is uncovered, players mark the points in the score box.
5. If a player calls a coordinate for an area which has D for dinosaur marked, one life chance is lost.
6. The game is over when either one player finds all the items or one player loses all their life chances.
7. Players then tally their total score for items found to see who has the most points.

A B C D E F G H I J K L M N O



1 2 3 4 5 6 7 8

Mark these letters on the map.

 shelter 50 points	 shelter 50 points	 shelter 50 points
 tools 20 points	 tools 20 points	 tools 20 points
 food 10 points	 food 10 points	 food 10 points
 dinosaur 10 points	 dinosaur 10 points	 dinosaur 10 points

You have two life chances.
You lose a chance each time
you meet a dinosaur.

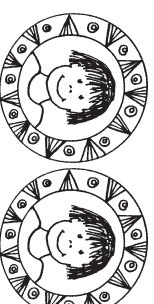

Game	Score	Total
1		
2		
3		

Dinosaurs

Focus Areas

- language: description
- dinosaur names
- spatial concepts

Preparation

- Enlarge to A3 and make duplicate copies of the Dinosaur Scene.
- Make duplicate copies of the Dinosaurs.
- Cut out the dinosaurs.

Suggested Use

1. Before playing, review the names of the dinosaurs.
2. Place a barrier between players. Players on each side of the barrier have:
 - a dinosaur scene
 - a matching set of dinosaurs
3. Players take turns to place a dinosaur on the dinosaur scene and give directions to the other player, who then places the same dinosaur in the same location, e.g. *“Put the Tyrannosaur in front of the volcano.”*
4. The game continues until all the dinosaurs are placed on the scene.
5. The barrier is then removed and the scenes are compared. Players note any differences that occurred.

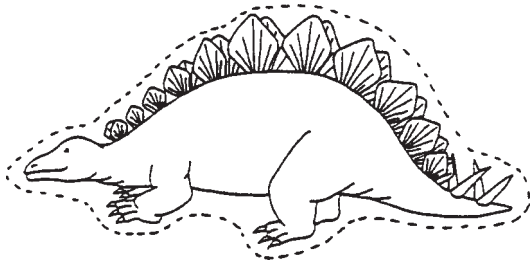

Stegosaurus

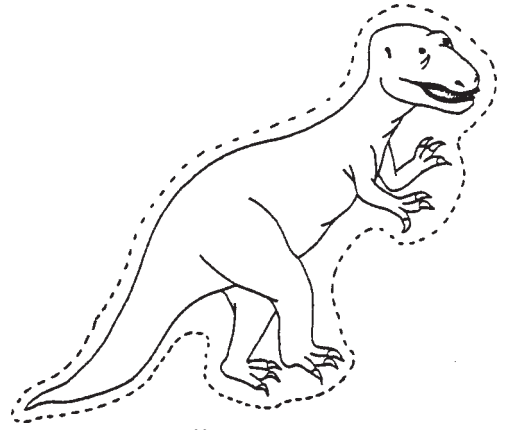

Allosaurus

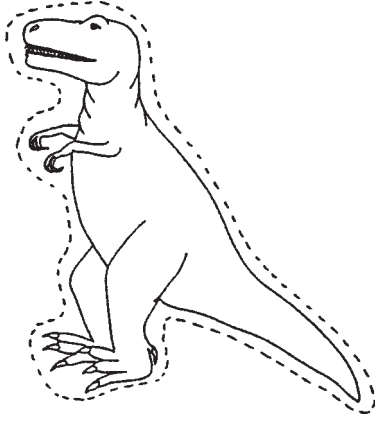

Tyrannosaurus

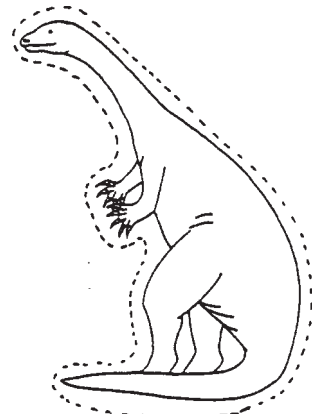

Plateosaurus

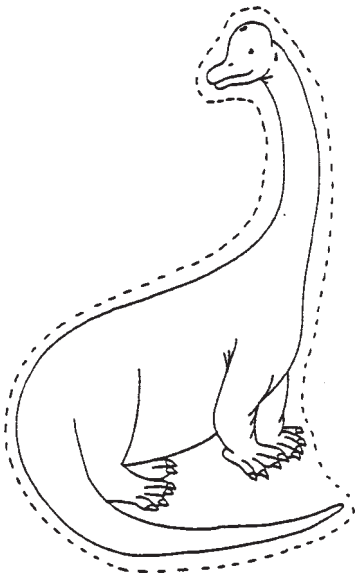

Brachiosaurus

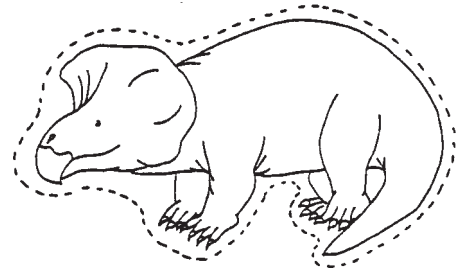

Protoceratops

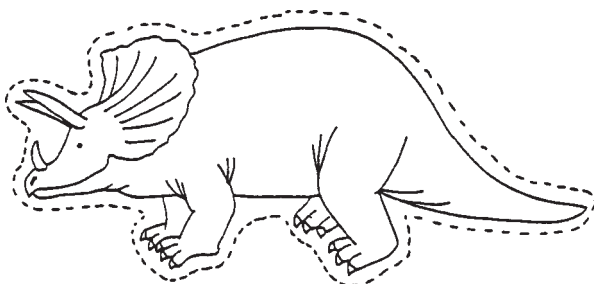

Triceratops

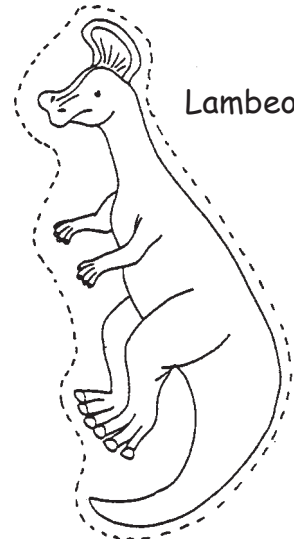

Lambeosaurus

Enlarge to A3 size when copying

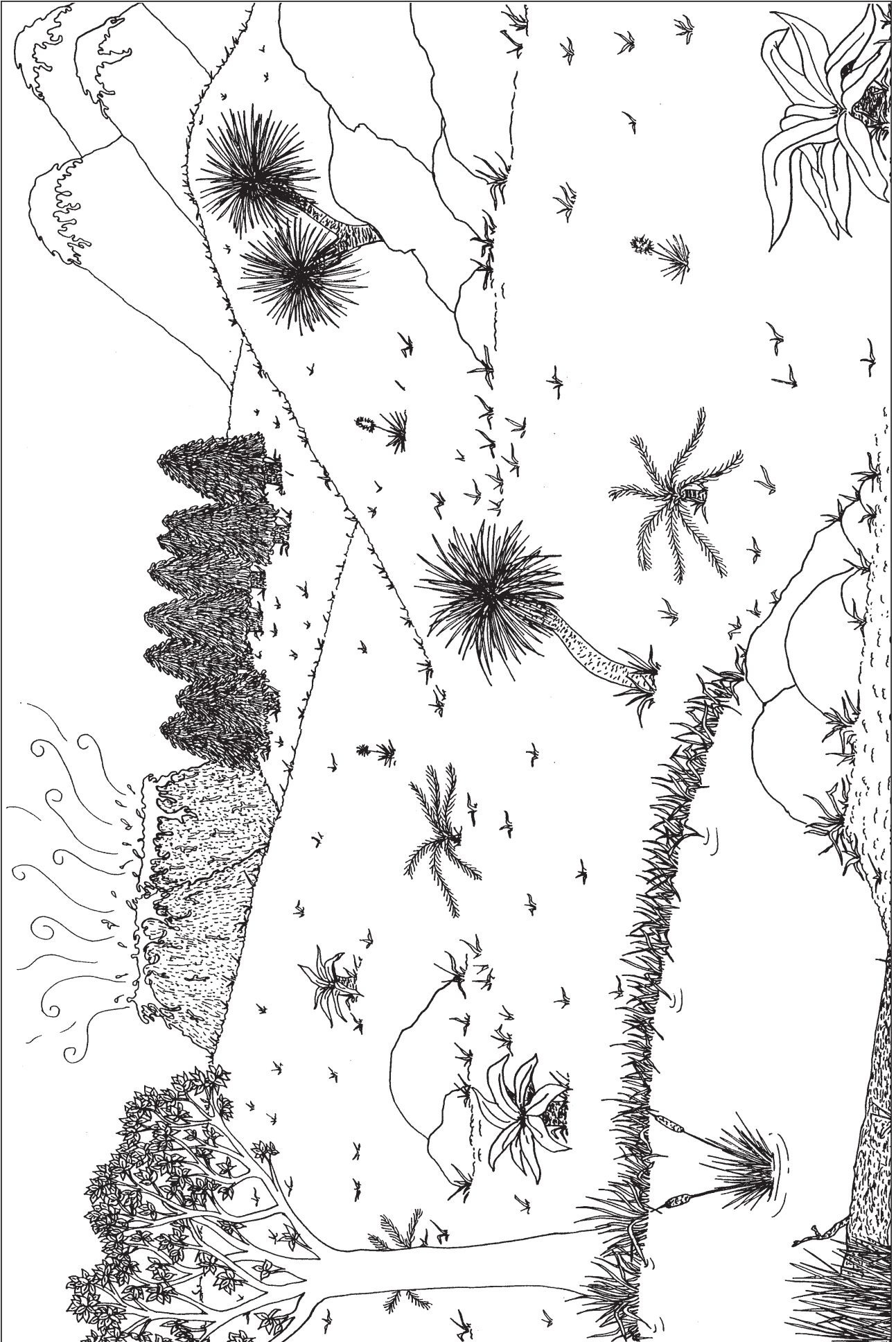

Grid Barrier Games

Grids

Using Grids

Grids are useful for many kinds of barrier games and can be used in combination with picture cards, objects, word cards, number cards or whatever you wish to focus on. For easy placement, colour the grid areas or mark shapes, patterns, pictures, letters, words or numbers on them. To focus on position concepts, children can learn to identify areas by row number and position number, e.g. “Row 2, Position 3”. Grids have been used in combination with many of the barrier games in this book. Some additional ideas for their use are detailed below.

Guess the Word

Write a word in each grid area (use word or spelling list words). One player places a marker (counter, block, etc) on a word. The other player uses questions to find which word it is but cannot say the word itself, e.g. “Does it end in the letters ‘er’?” Questions could be about word length, sound patterns, spelling patterns, etc.

bird	rain	fly	time
bike	bright	tie	mother
feather	paid	tight	heard

Guess My Rule

This is a variation on the above game. Write a word in each grid area. One player names a selection of the words to the other player that conform to a rule they have thought of. (e.g. *bird, mother, feather, heard*) The other player places a marker on each of the words in the selection and tries to discover what they have in common and guess the rule, (e.g. *They all have the /er/ sound.*) Rules could include words that share the same sound pattern, spelling pattern, meaning, be the same length, etc. **Note:** This game can also be played using numbers instead of words by choosing a group of numbers that all have something in common.

Describe the Number

Write a number in each grid area. Have a group of items (e.g. counters, blocks, cards, etc) to place on the grid areas. Players cannot use the numeral name but must describe the number in some way to tell where to place the item, e.g. “Put the red counter on a number that is the same as 3 groups of 4.” or “Put the blue triangle on the number that is 7 more than 21.”

Enlarge to A3 size when copying

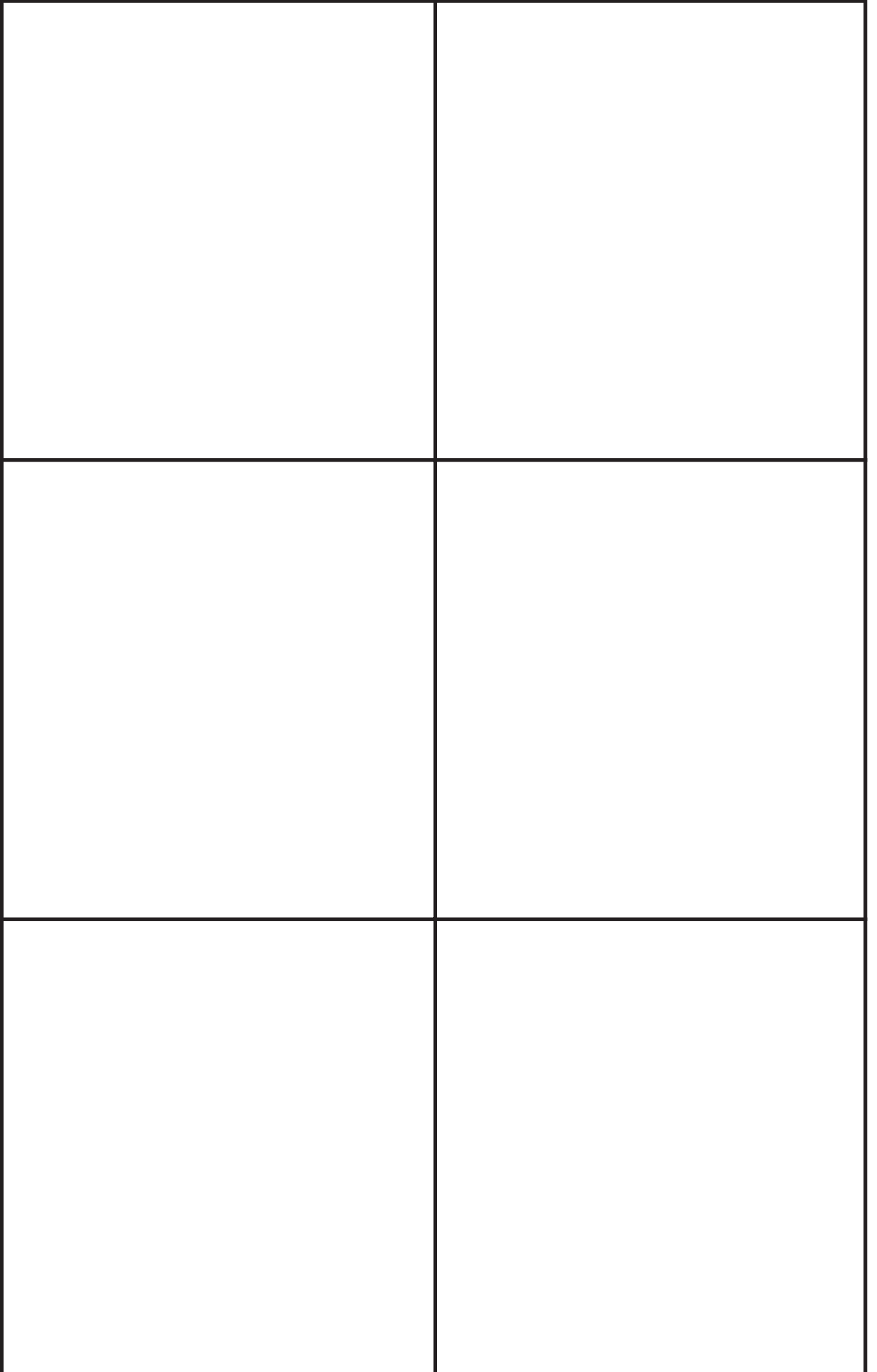

Enlarge to A3 size when copying

12 Grid

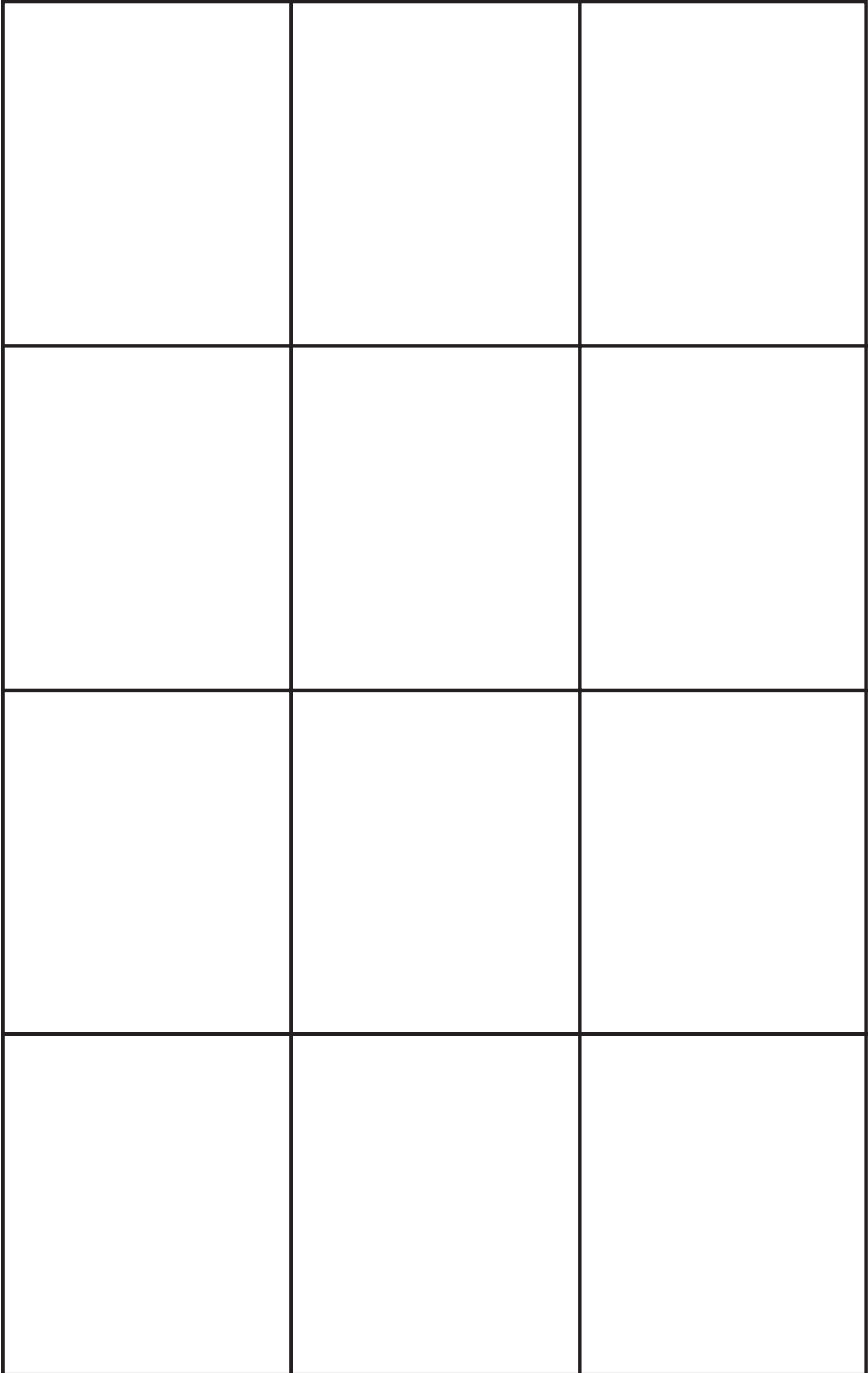

© 2003 Hands On Concepts

Develop Oral Language skills using over 40 original Barrier Games with Blackline Masters

plus many additional game ideas

Oral Language underpins the development of other language skills such as reading and writing. By focusing on activities which develop oral language skills, children learn to manipulate and control language to suit their purpose. **Barrier Games** are a great oral language tool as they provide opportunity to develop skills for both speaking (composing) and listening (reception/comprehension).

Barrier Games have been in existence for many years, and include games which require players to give and receive directions while being separated by some kind of barrier. A common barrier game many of us will have played is *Battleships*, a hit/miss game using coordinates. Barrier games can be created with all kinds of materials. This book includes ideas for creating your own games with common classroom materials as well as providing blackline masters for over 40 original barrier games.

Includes ideas for:

- **Getting Started**
- **Catering for Different Abilities**
- **Barrier Game Types & Styles**
- **Hints for Successful Use**
- **Variation & Extension Ideas**
- **Paired, Buddy, Small Group & Whole Class games**

Themes include:

- **About Us**
- **Fairytales & Fantasy**
- **Animals**
- **Grids for Word & Number games**

ISBN 0-9751212-0-0



9 780975 121207